

**CASE FILE
COPY**

NACA-TR-1

REPORT No. 1.

IN TWO PARTS.

REPORT ON BEHAVIOR OF AEROPLANES IN GUSTS.

BY THE MASSACHUSETTS INSTITUTE OF TECHNOLOGY.

**Part I.—EXPERIMENTAL ANALYSIS OF INSTANT LONGITUDINAL
STABILITY FOR A TYPICAL BIPLANE.**

By J. C. HUNSAKER.

Part II.—THEORY OF AN AEROPLANE ENCOUNTERING GUSTS.

By E. B. WILSON.

23

NACA TR 1

REPRODUCED BY
NATIONAL TECHNICAL
INFORMATION SERVICE
U.S. DEPARTMENT OF COMMERCE
SPRINGFIELD, VA. 22161

574

LIST OF ILLUSTRATIONS.

Fig. 1 a, b, c.	Art. 1. Model plans.
Fig. 2.	Art. 4. Curves L, D, M.
Fig. 3.	Art. 5. Performance curves.
Fig. 4 5, 6, 7, 8, 9.	Art. 8. Curves of X, Z, M.
Fig. 10.	Art. 10. Photo of oscillator.
Fig. 11.	Art. 10. Curve of damping coefficient.
Fig. 12.	Art. 14. Curves of Routh's discriminant.

REPORT No. 1.

PART 1.

EXPERIMENTAL ANALYSIS OF INHERENT LONGITUDINAL STABILITY FOR A TYPICAL BIPLANE.

By JEROME C. HUNSAKER.

ARTICLE 1.

INTRODUCTION.

A model of span 18 inches, representing a typical military tractor biplane, was tested in the wind tunnel of the Massachusetts Institute of Technology. The lift, drift, and pitching moment were measured for a series of angles of incidence corresponding to the maximum possible changes of flight attitude. Only the discussion of symmetrical or longitudinal changes is given here. A report on the lateral stability of the same model is reserved for a later date. From the observed rate of variation of the forces and pitching moment, it was possible to calculate the "derivatives" needed in the complete theory of longitudinal stability in still air. The damping of the pitching oscillation was also determined experimentally.

The method followed is that of L. Bairstow in his extension of Bryan's theory. Notation also follows Bairstow. The value of Routh's discriminant, which Bryan has shown to be a measure of dynamical longitudinal stability, has been calculated for six speeds, ranging from the maximum to the minimum possible speeds for the aeroplane type selected. The principal point of interest brought out in this connection is that stability falls off rapidly as speed decreases or angle of attack increases, and that while this aeroplane appears to be very stable at high speeds, it is frankly unstable at speeds below 47 miles per hour.

This instability at low speeds takes the form of an oscillation in pitch combined with changing in forward speed and a rising and sinking of the whole aeroplane, which, therefore, follows an undulatory flight path. The period of the undulation is about 12 seconds, and the amplitude doubles itself in less than 20 seconds. Obviously, the pilot can not safely abandon his controls at slow speed.

The importance of this demonstrated instability at low speeds should be appreciated in view of recent accidents with military aeroplanes when operated at slow speeds.

The entire investigation of inherent longitudinal stability was preliminary to the discussion of the effect of wind gusts. Naturally, it was first necessary to find a stable aeroplane and to obtain some idea

of the "range" of stability. It now appears that a typical aeroplane is inherently stable in the sense defined at high speeds only. The effect of gusts on the uncontrolled aeroplane will, therefore, be investigated only for the high-speed condition. At low speeds the aeroplane can not be left to itself in still air. Consequently, a discussion of its certain destruction if abandoned in gusty air appears unprofitable.

ARTICLE 2.

MODEL AND PROTOTYPE.

The type of aeroplane selected is a high-speed military biplane tractor known as *Curtiss JN2*. Shop plans of this aeroplane were kindly furnished by the Curtiss Aeroplane Co., Buffalo, N. Y., to whom acknowledgment must be made for much valuable assistance, including the experimental determination of moments of inertia, etc., by Dr. A. F. Zahm of that company.

The principal dimensions of the aeroplane were assumed as follows:

Weight full load.....	pounds..	1,800
Brake horsepower.....	horsepower..	110
Maximum speed for calculations.....	miles per hour..	79
Minimum speed for calculations.....	do.....	43.7
Total wing area (including ailerons).....	square feet..	384.0
Area fixed tail.....	do.....	23.0
Area horizontal rudder.....	do.....	19.0
Area vertical rudder.....	do.....	7.8
Span of wings.....	feet..	36.0
Chord of wings.....	do.....	5.3
Gap between wings.....	do.....	5.3
Length of body.....	do.....	26.0

The model was made geometrically similar to its prototype and one twenty-fourth scale. The general features are shown in the drawings of the model. (Figs. 1 *a, b, c.*) The model was an exact copy of the aeroplane except for the propeller and wing wiring, which features were omitted. Also wing struts were made round instead of "stream-line" in section. Since it is well known that the resistance of a series of similar aeroplanes varies somewhat less rapidly than the square of the speed and square of a linear dimension, due to skin friction, it is believed that the prediction of the resistance of the full size aeroplane from the observed model resistance will still be a fair estimate in spite of omissions on the model.

For simplicity, the model was made with the trailing ailerons or wing flaps integral with the wings. This somewhat increases the effective supporting area. Also the fixed tail and elevator were made in one, corresponding to the elevator held fast in its neutral position. These points are made clear on the drawings of the model.

ARTICLE 3.

GENERAL WIND TUNNEL PROCEDURE.

The model was tested in the 4-foot wind tunnel at a velocity of 30 miles per hour. The wind tunnel and aerodynamical balance are duplicates of the installation of the National Physical Laboratory, Teddington, England, and reference should be made to the Technical

FIGURE 1-B.

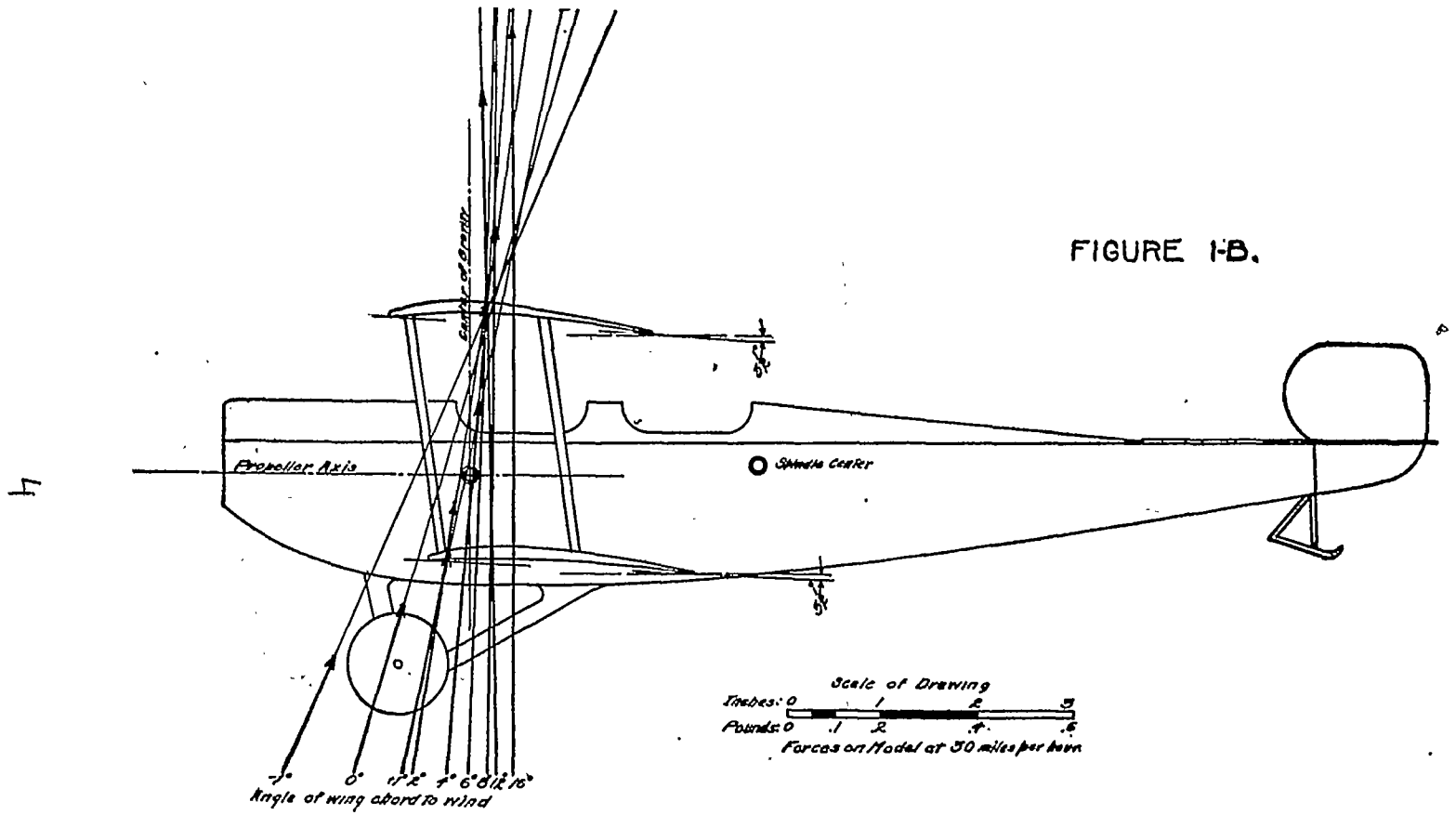

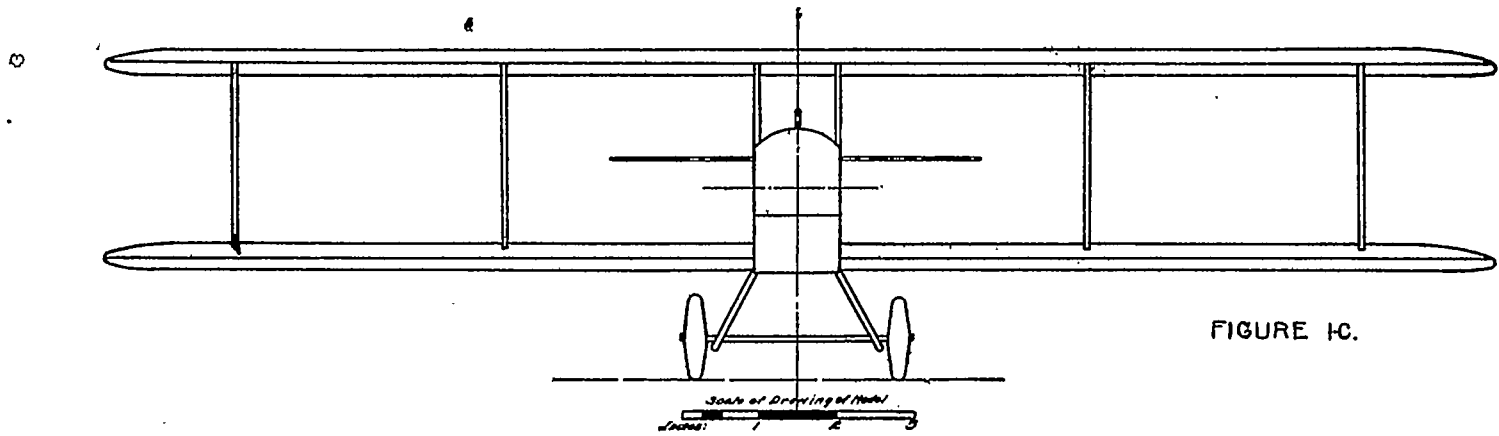

FIGURE 1C.

Report of the Advisory Committee for Aeronautics, London, 1912-13, for detail description and methods of operation.

In general, it may be stated that the wind tunnel provides a wind constant in velocity within 1 per cent, which velocity is further constant across the working cross section of the tunnel within $1\frac{1}{4}$ per cent. Velocity is measured by a suction plate calibrated against a standard Pitot tube with a precision of one-half per cent. The model is mounted on the balance in various attitudes of pitch or yaw, and in such positions are measured the three forces and three couples produced by the wind along and about three mutually perpendicular axes in space. From a knowledge of the variation of these forces and couples with change of attitude, the so-called "resistance derivatives" of Bryan's¹ theory of dynamical stability may be computed.

The theory of stability also requires the determination of the damping of oscillations about the center of gravity of the aeroplane. A special oscillating apparatus was built for these tests which will be described below. By oscillating the model in the wind and observing the decrement of amplitude with time, it was possible to estimate the "rotary derivatives."

ARTICLE 4.

LONGITUDINAL TESTS.

The model was mounted on the balance with its wings in a vertical plane by means of a vertical rod driven into the body at the point shown on figure 1*b*. By swinging the model about the vertical axis passing through the spindle, the angle of wind to the wing chord was varied from $+20^\circ$ to -8° . At each attitude the force across the wind or "Lift," force down wind or "Drift," and the pitching moment about the spindle were measured. The signs were taken so that an actual lift, actual head resistance, and a stalling moment are positive. The wind velocity was 30 miles per hour of standard dry air at 15° C. and 776 mm. Hg. The experimental points are shown on figure 2, where forces are in pounds and moments in inch-pounds. The precision of measurement is within 1 per cent.

For a given attitude, the resultant force on the model in pounds at 30 miles per hour is $R = \sqrt{L^2 + D^2}$. This resultant makes an angle with the wind direction given by $\alpha = \tan^{-1} \frac{L}{D}$. The force R is observed to have a pitching moment M about the spindle axis. It may then be assumed to be situated so that the perpendicular from this axis to R is given by $x = \frac{M}{R}$. The vector R is thus determined in magnitude, direction, and line of application. The resultant force vectors R are shown on figure 1*b* to a scale 1 inch equals 0.2 pound. The vector R is purely an algebraic substitution for the complicated system of forces and couples acting on the aeroplane. The vectors are drawn relative to the aeroplane.

The center of gravity was assumed to lie as shown near the intersection of the propeller axis with the resultant force vector for 4° . At this attitude, then, the pitching moment should be nearly zero.

¹ G. H. Bryan, *Stability in Aviation*.

The c. g. location determined for the actual aeroplane after extensive trial flights is almost identical.

It is seen that for angles smaller than 4° , R passes forward of the

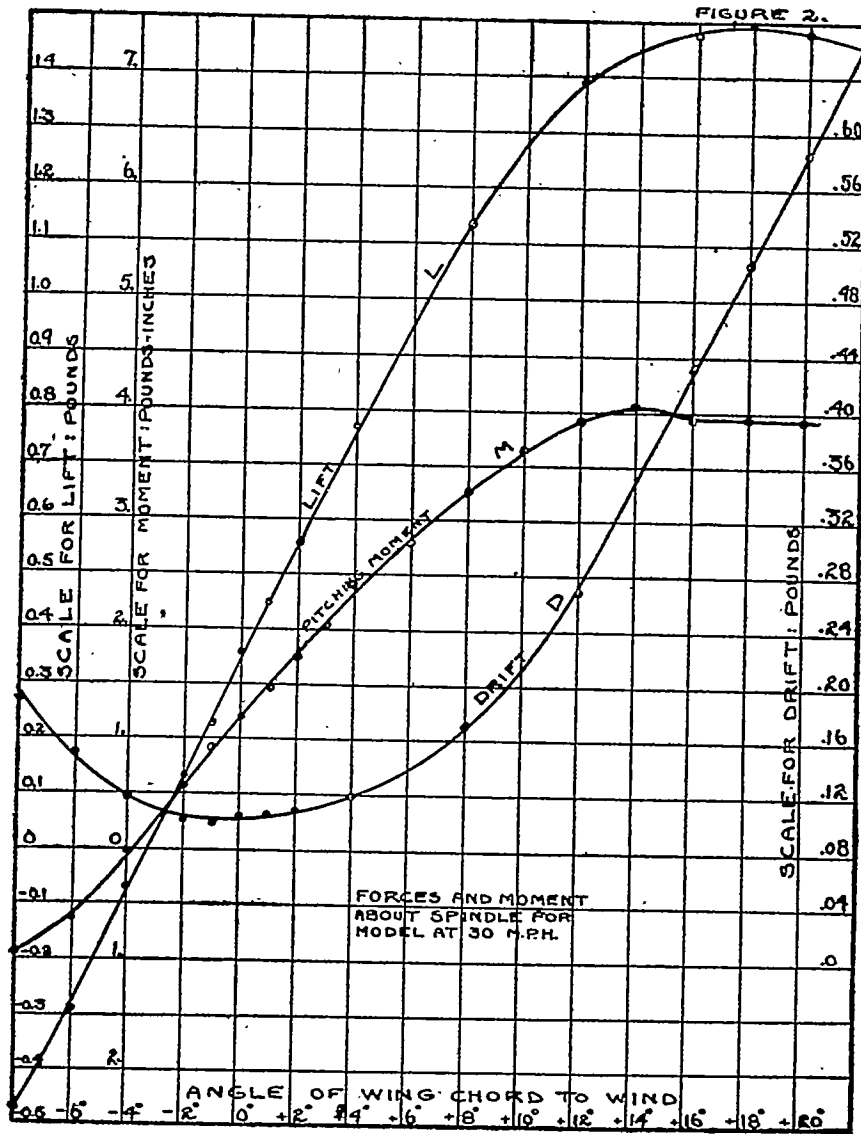

c. g. and for angles greater than 4° , it passes to the rear. The aeroplane is longitudinally stable in a static sense. It will be shown below that it is not always dynamically stable.

ARTICLE 5.

PERFORMANCE CURVES.

The lift and head resistance or "drift" of the full scale aeroplane were assumed to be approximately given by the relation:

$$\frac{\text{Force on model}}{\text{Force on aeroplane}} = \left(\frac{30}{24V}\right)^2$$

FIGURE 3.

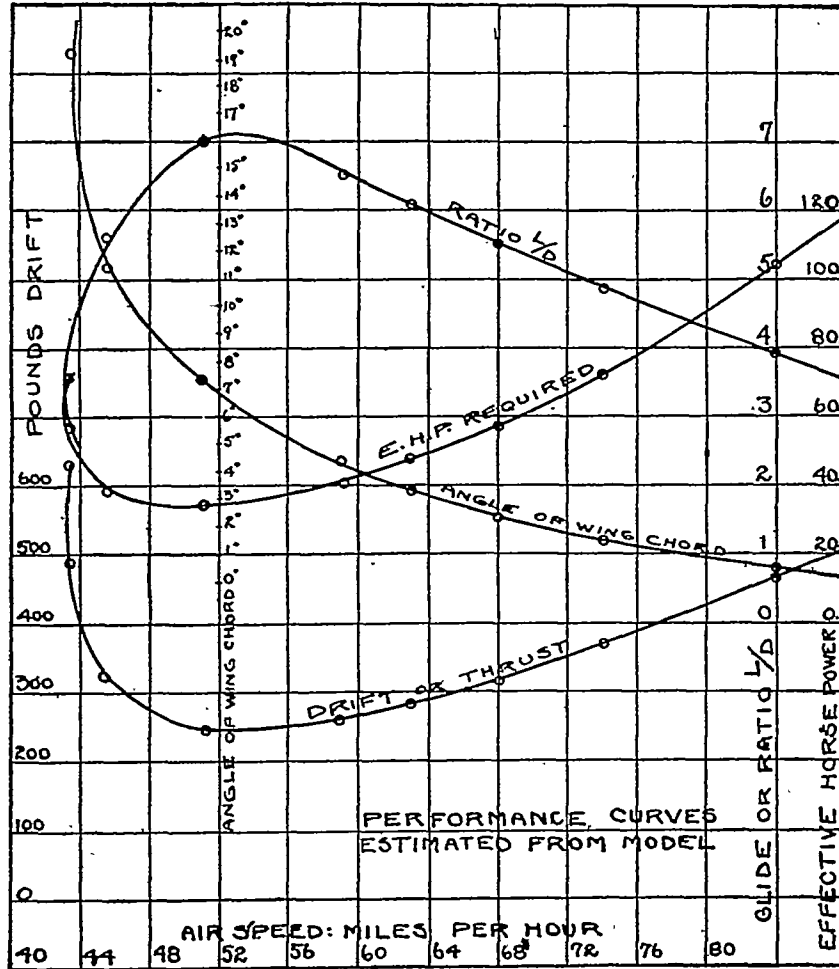

when V is the flying speed of the aeroplane in miles per hour. The above relation holds, of course, only for the same attitude of model and aeroplane. The weight of the aeroplane, 1,800 pounds, must equal the lift in flight. Hence:

$$V = \frac{30}{24} \sqrt{\frac{1800}{\text{Lift on model}}}$$

A series of speeds V was computed for a series of attitudes of the aeroplane, and the aeroplane drift at each attitude was then computed from:

$$D \text{ full size} = D \text{ model} \times \frac{1}{24} \times \left(\frac{V}{30}\right)^2$$

In figure 3 are given curves of drift, effective horsepower required, angle of wing chord to wind and ratio weight to drift plotted on V as abscissae. For our calculations a maximum speed of 79 miles and a minimum of 43.7 miles were selected corresponding to angles of wing chord to wind of 1° and 15.5° , respectively.

The curve of E.H.P. on figure 3, indicates that 87 propeller horsepower is necessary for a speed of 79 miles. If the propeller has an efficiency of 80 per cent, the motor must develop at least 110 brake horsepower. The original designs contemplated as maximum speed of about 80 miles per hour for a 120 brake horsepower motor, which appears very reasonable. As actually built this type was given a rated 90 horsepower motor. Assuming 70 E.H.P. delivered to the propeller a speed of 73 miles per hour is indicated by our curves. It is reported that the speed of this aeroplane was actually 73 miles per hour.

ARTICLE 6.

CHOICE OF AXES—NOTATION—UNITS.

Axes for reference are assumed fixed in the aeroplane and moving with it in space. The origin is at the center of gravity. For steady horizontal flight at a given attitude the axis of Z is vertical, the axis of X Horizontal and directed to the rear in the plane of symmetry, and the axis of Y is horizontal and directed toward the left-wing tip. Forces along these axes are denoted by X , Y , Z and are expressed in pounds per unit mass. Moments are L , M , N and are given in pounds-feet per unit mass.¹

Angles of roll, pitch and yaw from the normal flying attitude are denoted by φ , θ and ψ . Angular velocities of roll, pitch and yaw are p , q , r in radius per second. The signs of moments, angles and angular velocity are positive considered in the directions \overline{XY} , \overline{YZ} or \overline{ZX} .

Moments of inertia referred to axes X , Y , Z are denoted by mK_x^2 , mK_y^2 , mK_z^2 where m is the mass of the aeroplane and K_x , K_y , K_z corresponding radii of gyration.

ARTICLE 7.

EQUILIBRIUM CONDITIONS.

In normal horizontal flight in still air a state of equilibrium is assumed such that the power available maintains the aeroplane at such a speed that the weight is just sustained. Since the lift of an aeroplane wing is also a function of its attitude or angle of attack, it is further assumed that the attitude is proper for the speed. In

¹ Unit mass is the slug equal to 32.17 pounds weight.

normal horizontal flight the axis of X is parallel to the apparent wind direction and is hence horizontal. Let θ be the angle of pitch of the aeroplane away from its normal attitude. Then normally θ is zero. Likewise if the aeroplane is in equilibrium in its flight, the angular velocity of pitch is zero and also the pitching moment, M_0 .

At high speed, for example 79 miles, the axis of X is horizontal and makes an angle of 1° with the wing chord. At low speed, new axes are chosen such that the axis of X is still horizontal but makes an angle of 15.5° with the wing chord. The axes are fixed by the equilibrium conditions for flight and differ for each normal flying attitude. Oscillations about the normal flight path when the motion is disturbed are referred to the above defined axes which are assumed fixed in the aeroplane and moving with it in space.

The pitching moment curve observed for the model shows zero moment for an angle of wing chord of 4.5° and a diving moment at larger angles. For slow flight, it is assumed that the pilot by proper setting of his horizontal rudder impresses an equal stalling moment on the machine so that the net pitching moment is zero. The effect is to move the pitching moment curve parallel to itself by the algebraic addition of a stalling moment so that its ordinate has zero value for the desired flight attitude.

ARTICLE 8.

TRANSFORMATION OF AXES.

It is convenient to measure in the wind tunnel the lift and drift about axes always vertical and horizontal in space. For the oscillations of the aeroplane it is convenient to consider the forces referred to axes fixed in the aeroplane as described above. The transformation is effected in the usual way by means of the formulæ:

$$\begin{aligned} m Z' &= L \cos \theta + D \sin \theta, \\ m X' &= D \cos \theta - L \sin \theta, \end{aligned}$$

where θ is the angle of pitch of the aeroplane away from its normal attitude, considered positive for stalling angles. Here L and D are lift and drift on the model in pounds, and $m X'$ and $m Z'$ corresponding forces in pounds along the axes X and Z . The model forces Z' , X' are converted to Z , X , full size, by multiplying by the square of the speed and linear dimension ratios. The following tables carry out the required transformation.

The pitching moment M is independent of the longitudinal shift of axes and varies only as the square of the speed. Curves of X , Z and M for the different flight attitudes are plotted on figures 4, 5, 6, 7, 8, and 9. The transformation of the moment about the spindle to the corresponding moment about the c. g. of the full-size aeroplane is given below.

$i=1^\circ$, $V=79$ miles, $m=55.9$ slugs.

i	θ	L	D	Z	X
- 4	- 5	-0.08	+0.115	- 6.4	+7.7
- 2	- 3	+ .14	.104	+ 10.8	7.8
0	- 1	.35	.102	24.9	7.76
+ 1	0	.45	.104	32.9	7.4
+ 2	+ 1	.56	.108	40.0	7.1
+ 4	+ 3	.765	.118	54.9	5.6
+ 8	+ 7	1.13	.165	81.0	1.9
+12	+11	1.39	.270	100.0	-.7
+16	+15	1.48	.428	109.0	-2.05
+20	+19	1.48	.581	112.5	-4.7

 $i=7^\circ$, $V=51.8$ miles.

0	- 7	+0.95	+0.102	+10.3	+4.42
1	- 6	.45	.104	13.4	4.64
2	- 5	.56	.108	16.9	4.79
4	- 3	.765	.118	23.3	4.85
7	0	1.05	.150	32.2	4.60
12	+ 5	1.39	.270	48.0	4.54
16	9	1.48	.428	47.0	5.90
20	13	1.48	.581	48.2	7.12

 $i=10^\circ$, $V=47$ miles.

6	- 4	+0.96	+0.136	+24.0	+5.14
8	- 2	1.13	.165	28.4	5.18
10	0	1.28	.21	32.4	5.21
12	+ 2	1.39	.27	35.4	5.56
14	+ 4	1.45	.348	37.2	6.24

 $i=12^\circ$, $V=45.2$ miles.

8	-4	1.13	0.165	26.1	5.68
10	-2	1.28	.21	29.6	5.83
12	0	1.39	.27	32.4	6.29
14	+2	1.45	.348	34.0	6.92
16	+4	1.48	.428	35.2	7.56

 $i=14^\circ$, $V=44.2$ miles.

10	-4	1.28	0.21	28.3	6.67
12	-2	1.39	.27	30.8	6.87
14	0	1.45	.348	32.4	7.22
16	+2	1.48	.428	33.3	7.43
18	+4	1.50	.508	34.2	7.62

$i=15.5^\circ$, $V=43.7$ miles.

i	θ	L	D	Z	X
9.5	-6	1.24	0.196	26.4	7.1
13.5	-2	1.40	.330	30.6	8.25
15.5	0	1.48	.408	32.2	8.9
17.5	+2	1.49	.482	33.0	9.4
19.5	+4	1.49	.561	33.4	10.0

CONVERSION OF PITCHING MOMENTS.

mM_s = moment about spindle in inch pounds on model.
 mM_{cg} = moment about c. g. in inch pounds on model.
 $b=3.04$ inches, c. g. forward of spindle.
 $a=0.10$ inches, c. g. above spindle.
 Axis of X 3.5° to wing chord.
 M = pitching moment about c. g. full size, full speed, in pounds feet per unit mass.
 $mM_{cg} = mM_s - mZ'b - mX'a$.
 i = angle of wing chord to wind, degrees.
 θ = angle of axis of X to wind, degrees.

i	θ	L	D	mZ'	mX'	mM_s	mM_{cg}	$1^\circ M$	$7^\circ M$	$10^\circ M$	$12^\circ M$	$14^\circ M$	$15^\circ M$
-3	-8	+0.130	+0.123	-0.146	+0.104	-0.022	+0.21	+29.9	+12.9	9.36	9.17
-2	-6	+ .080	.105	+ .068	.112	+ .400	+ .18	+25.7	+11.0	8.0	7.85
-1	-4	+ .300	.102	.293	.121	+1.05	+ .15	+21.4	+ 9.2	6.67	6.54
+1	-2	.510	.105	.508	.123	1.05	+ .10	+14.3	+ 6.1	4.46	4.37
+2	-1	.615	.110	.613	.122	1.03	+ .08	+11.4	+ 4.9	3.50	3.49
+3	0	.715	.115	.715	.115	2.21	+ .03	+ 4.28	+ 1.8	+ 1.35	+ 1.32
+4	+1	.810	.122	.812	.107	2.43	0	0	0	0	0
+5	+2	.810	.130	.915	.088	2.71	-.08	-11.4	- 4.9	- 4.0	- 3.72	- 3.56	- 3.49
+6	+4	1.09	.157	1.10	.081	3.17	-.18	-25.7	-11.1	- 9.07	- 8.40	- 8.02	- 7.88
+7	+8	1.37	.252	1.40	.053	3.81	-.40	-57.0	-24.5	-20.2	-18.7	-17.9	-17.5
+11	+12	1.48	.408	1.51	.184	4.00	-.60	-85.5	-38.8	-30.3	-28.0	-28.8	-28.2
+15	+16	1.49	.561	1.54	.331	3.95	-.76	-108.0	-46.6	-33.9	-33.2

ARTICLE 9.

RESISTANCE DERIVATIVES, LONGITUDINAL.

Notation follows Bairstow,¹ to whose paper reference should be made for the detailed discussion of "derivatives." In the theory of small oscillations, the aerodynamic forces X_0 , Z_0 , and pitching moment, M_0 , are eliminated by the conditions of equilibrium. In disturbed motion, disturbances in normal flying speed and attitude cause changes in the quantities, X , Z , and M .

Let U be the normal flying speed and u , w and q small changes in horizontal and vertical velocity components and angular velocity of pitch. If the disturbance be small, u , w and q are small with respect to U . For example, the function

$$X = f(U + u, w, q)$$

may be expanded into the approximate form

$$X = X_0 + uX_u + wX_w + qX_q$$

a linear function of the small quantities u , w , q . The coefficients X_u , X_w , X_q are the so-called resistance derivatives of the theory of

¹ Technical Report of the Advisory Committee for Aeronautics, London, 1912-13.

FIGURE 4.

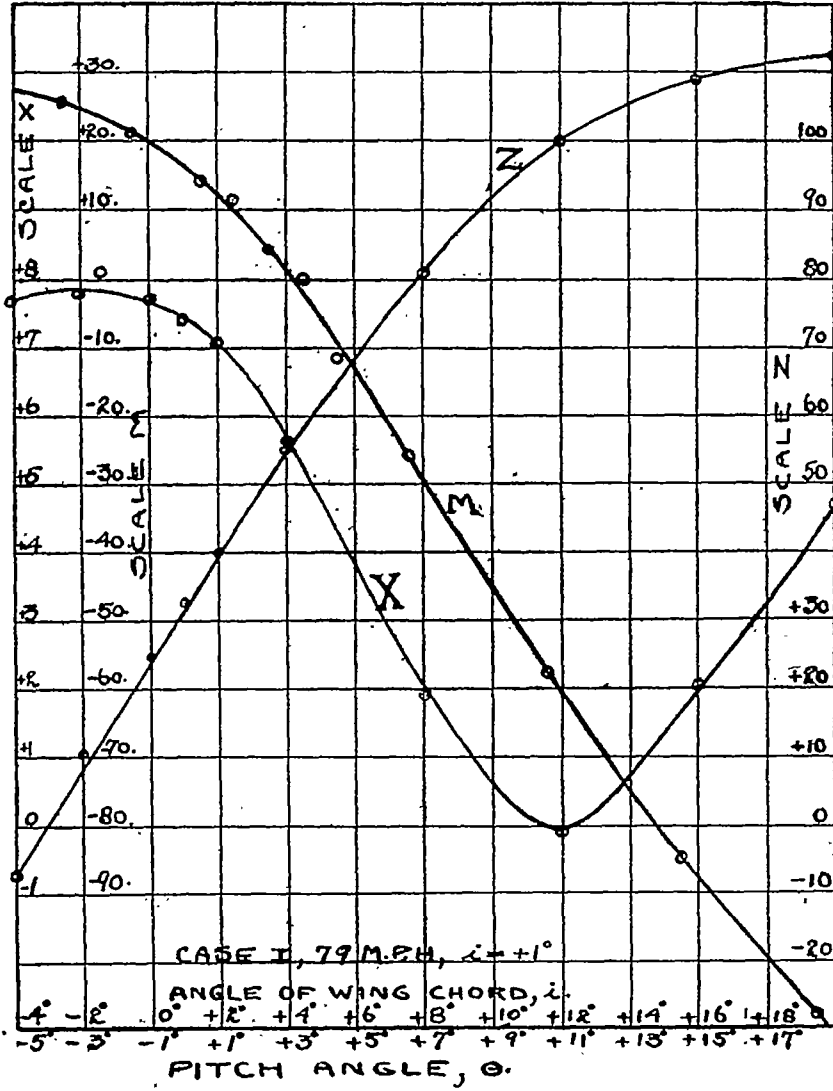
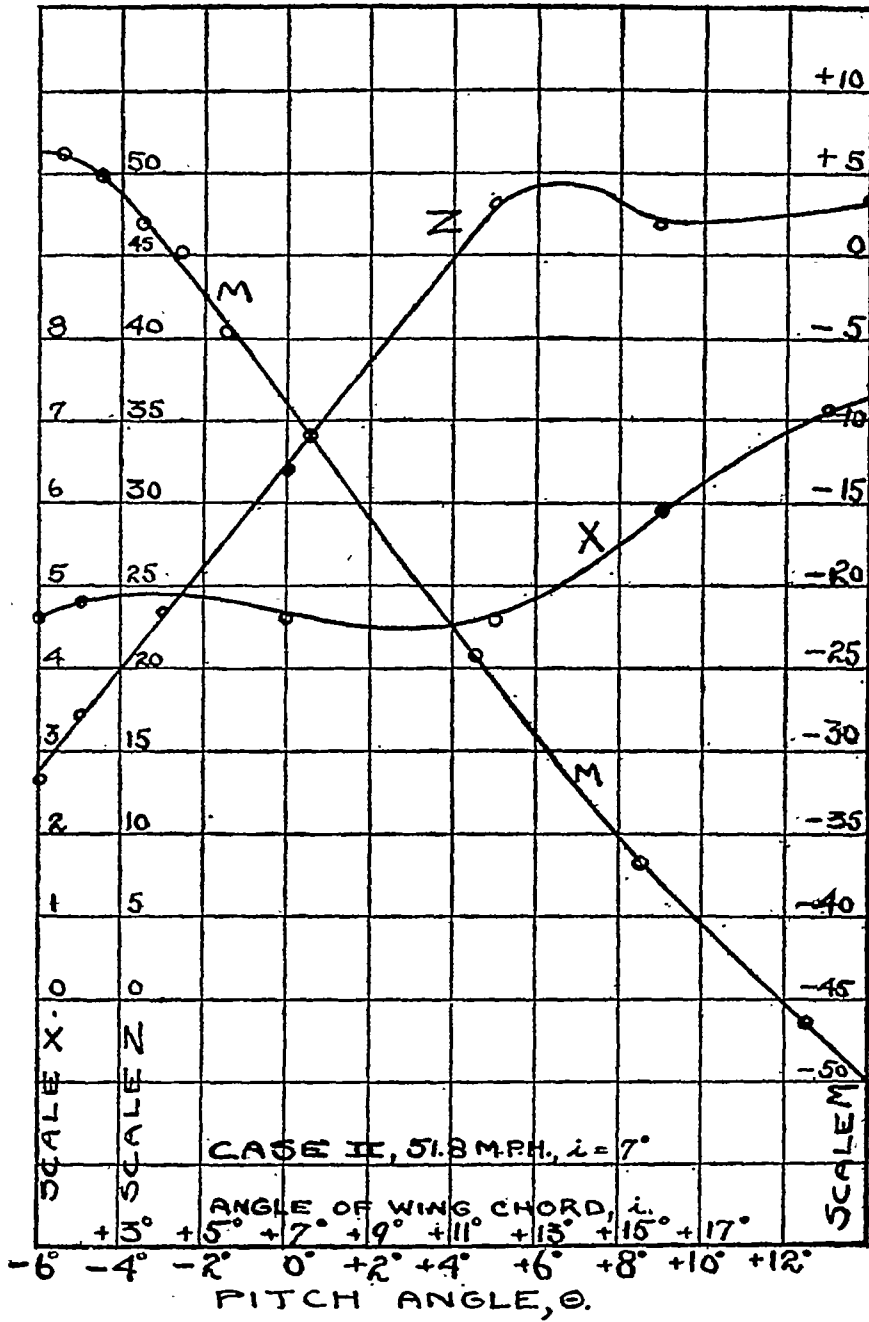

FIGURE 5.



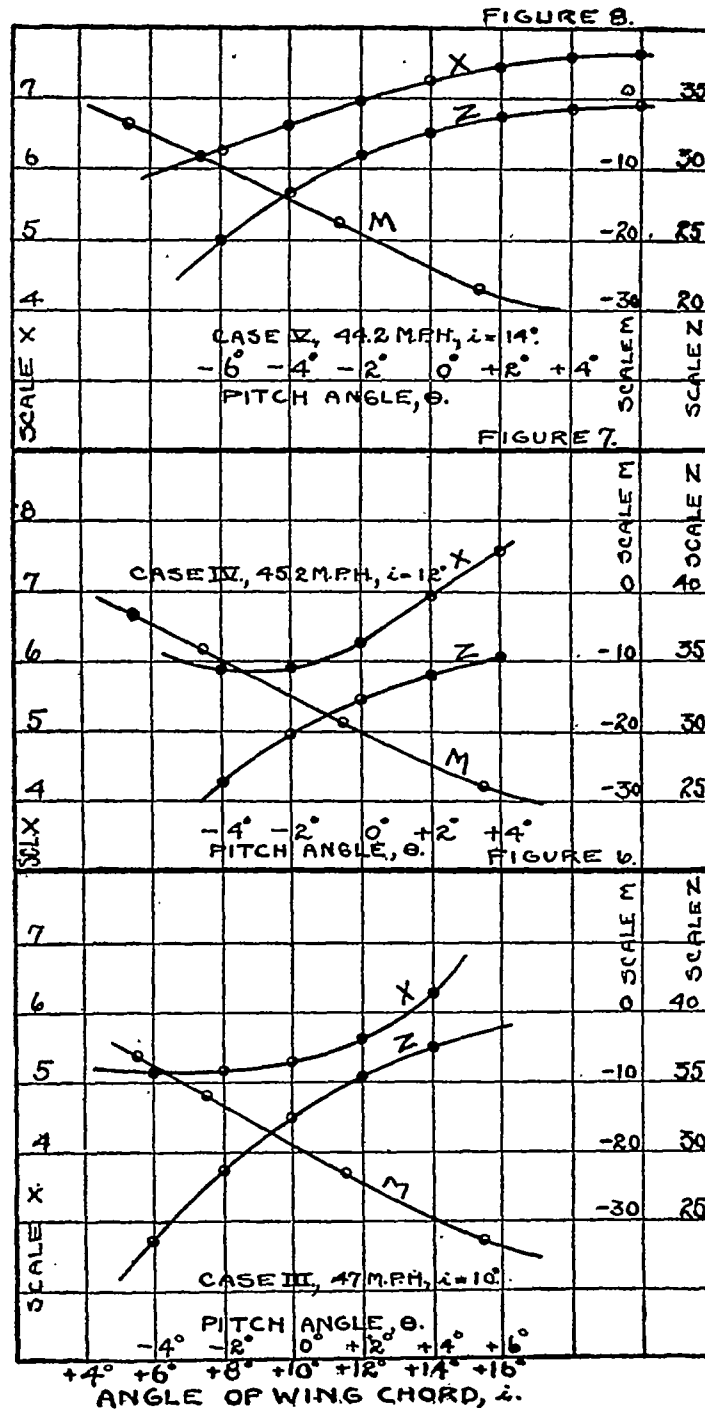
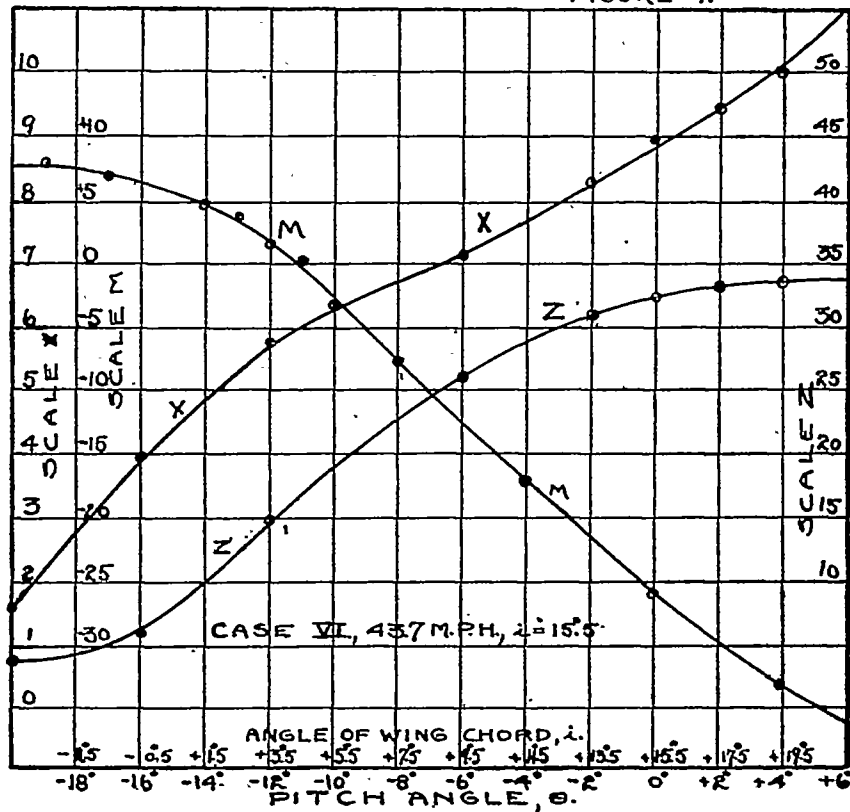

FIGURE 9.



small oscillations, and physically represent the slope of a curve of X on a base $u, w,$ or q .

Similarly

$$Z = Z_0 + uZ_u + wZ_w + qZ_q$$

$$M = M_0 + uM_u + wM_w + qM_q$$

From the conditions of equilibrium, X_0 is balanced by the propeller thrust, Z_0 by the pull of gravity or $Z_0 = g$, and $M_0 = 0$. Also, Bairstow has shown that X_q and Z_q may be neglected.

X_u is the rate of change of X with change in forward speed. But since X is a function of forward speed squared we may write:

$$X_u = \frac{\Delta X_0}{\Delta U} = \frac{2X_0}{U}$$

and

$$Z_u = \frac{2Z_0}{U}$$

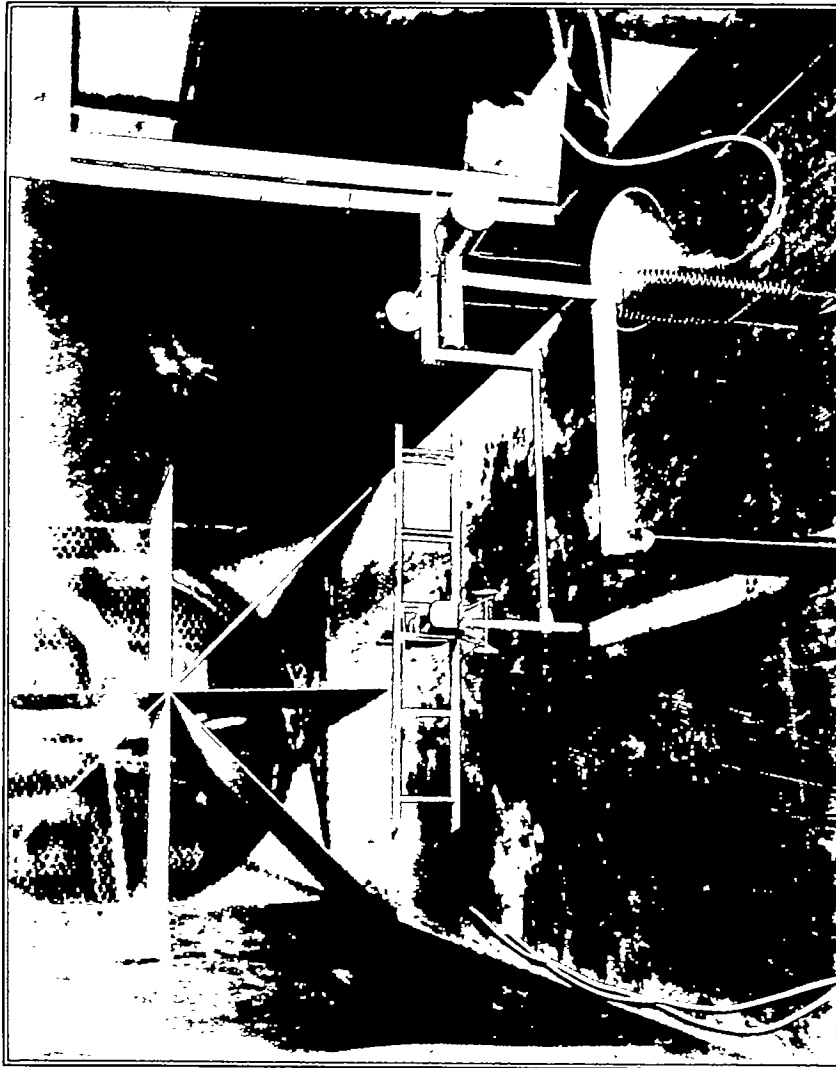

64-a

These coefficients may be obtained directly by calculation since $X_o = \frac{\text{Drift}}{m}$, and $Z_o = g$. For example, at 79 miles per hour, $U = -115.5$ feet per second and $Z_o = 32.2$. Then

$$Z_u = \frac{2 \times 32.2}{-115.5} = -.557$$

Also at 15°5, $U = -63.8$ feet per second and

$$X_u = \frac{2 \times 10}{-63.8} = -.276$$

The derivatives X_w , Z_w , M_w represent the effect of a vertical component of velocity. From the well-known method of velocity composition, the vertical velocity w acts with the horizontal velocity U to cause the apparent wind to have an inclination to the horizontal of $\tan^{-1} \frac{w}{U}$. This inclination is given to the model in the wind tunnel, and X , Z , and M measured for various pitch angles.

But $\Delta\theta = \tan^{-1} \frac{w}{U} = 57.3 \frac{w}{U}$, when $\Delta\theta$ is a small angle in degrees.

$$\therefore X_w = \frac{\Delta X}{w} = \frac{57.3}{U} \cdot \frac{\Delta X}{\Delta\theta}$$

$\frac{\Delta X}{\Delta\theta}$ is the slope of a curve of X on pitch angle as base. For example, from figure 4, $\frac{\Delta X}{\Delta\theta} = \frac{-.65}{2}$ and

$$X_w = \frac{57.3}{-115.5} \cdot \frac{-.65}{2} = +0.162$$

Similar formulas are used to compute Z_w and M_w . It may be noted that the method assumes that for small oscillations, hence small changes θ , the tangent may be substituted for the actual curve. The limit of validity is obviously the range of pitch angle over which the tangent to the curve is not greatly changed. This range is usually about 4 to 8 degrees.

The values of the resistance derivatives calculated in this manner will be found tabulated later.

ARTICLE 10.

DAMPING.

The damping of pitching about the c. g. is represented by the rotary derivative M_q . For an angular velocity $\frac{d\theta}{dt} = q$, a damping moment $q M_q$ is exerted on the aeroplane.

To measure this aerodynamic damping, the special oscillating apparatus was designed which is shown by the photograph of figure 10. The model is mounted on a massive bracket which pivots about the

two points shown. Fore-and-aft arms carry counterweights which are adjusted to give a reasonable natural period. The spiral springs bear in notches on the arms by means of knife-edged shackles. The springs insure that the motion shall be oscillatory. The assumed c. g. location of the aeroplane model is arranged to be on the axis of rotation. The actual center of gravity of the apparatus is not considered.

Friction is kept small by careful design of the steel pivots, which are hardened steel points bearing in tool steel cones. The spring knife edges are glass hard. It was found that a convenient period is about one-half second. In still air the apparatus will rock more than 300 times before the amplitude is diminished by friction to one-ninth of the initial displacement.

The moment of inertia of the entire oscillating mass was calculated and then checked by an independent experimental determination.

Let:

I = moment of inertia of all oscillating parts in slug foot-units.

m' = mass of all oscillating parts in slugs.

M_o = moment of air forces on model at rest.

M_s = moment of springs at rest.

$K\theta$ = additional moment of springs when deflected.

c = c. g. of entire apparatus above pivot, feet.

θ = angle of pitch from normal attitude in radians.

$\mu_o \frac{d\theta}{dt}$ = damping moment due to friction.

$\mu_w \frac{d\theta}{dt}$ = damping moment due to wind on apparatus.

$\mu_m \frac{d\theta}{dt}$ = damping moment due to wind on model.

$cm'\theta$ = static moment due to gravity.

The equation of motion then is:

$$I \frac{d^2\theta}{dt^2} + (\mu_o + \mu_w + \mu_m) \frac{d\theta}{dt} + (K - cm')\theta + M_o - M_s = 0$$

But $M_o = M_s$, by the initial condition of equilibrium. Let

$$\mu = \mu_o + \mu_w + \mu_m; \text{ then } I \frac{d^2\theta}{dt^2} + \mu \frac{d\theta}{dt} + (K - cm')\theta = 0$$

The solution of this equation is well known to be:

$$\theta = C e^{-\frac{\mu t}{2I}} \cos \left\{ t \sqrt{(K - cm') \frac{1}{I} - \frac{\mu^2}{4I^2} + \alpha} \right\},$$

where O and α are arbitrary constants. If time be counted when the amplitude of swing is a maximum then $\cos\{-\} = 1$, and $\theta = \theta_o$, the initial displacement. Also if the number of beats be counted by

observing the times for succeeding maxima, a plot of amplitude on time will have for its equation the simple form:

$$\theta = \theta_0 e^{-\frac{\mu t}{2I}}$$

The coefficient μ is the logarithmic decrement of the oscillation and must be numerically positive to insure that the oscillation dies out with time.

The apparatus was fitted with a small reflecting prism by which a pencil of light was deflected toward a ground glass plate set in the roof of the tunnel. Nine lines spaced 0.2 inch were ruled on this plate. With the model at rest the beam of light was brought to a sharp focus on the line marked zero. By means of a trigger the observer started an oscillation of the model, and the spot of light was observed to oscillate across the scale. The time, t , was observed in which an oscillation was damped from an amplitude of 9 to an amplitude of 1, for example.

Then: $\log_e \frac{\theta_0}{\theta} = \frac{\mu}{2I} t = \log_e 9$, and knowing I and t , μ is calculated.

Preliminary tests showed that the same value of μ was obtained whether the timing stopped at $\theta = 5, 4, 3, 2$, or 1.

Oscillation tests were made at five wind velocities varying from 5 to 35 miles per hour. The coefficient μ appeared to vary approximately as the first power of the velocity.

Similar tests were made with the model for no wind to determine μ_0 , which may be said to be due almost wholly to friction and very slightly to the damping of apparatus and model moving through the air.

Likewise μ_w was obtained by oscillating the apparatus without model in winds from 5 to 35 miles per hour.

The coefficient μ_m has the dimensions $^1 \rho l^4 V$, where ρ is density of air, l a linear dimension, and V the velocity of the wind. To convert μ_m to M_q for the full-size machine at full speed, multiply by the fourth power of 24, the scale, and by the ratio of full speed to model speed.

The numerical results of tests of the pitching oscillation follow. Note that the damping of the pitching falls off for low speeds. This contributes to the difficulty of providing sufficient stability at low speeds.

In the tables following, the number of beats, n , is recorded as a general check and is not used. Recorded values of n and t are the means of three or five separate observations.

¹Bairdrow, loc. cit., p. 176.

FIGURE II.

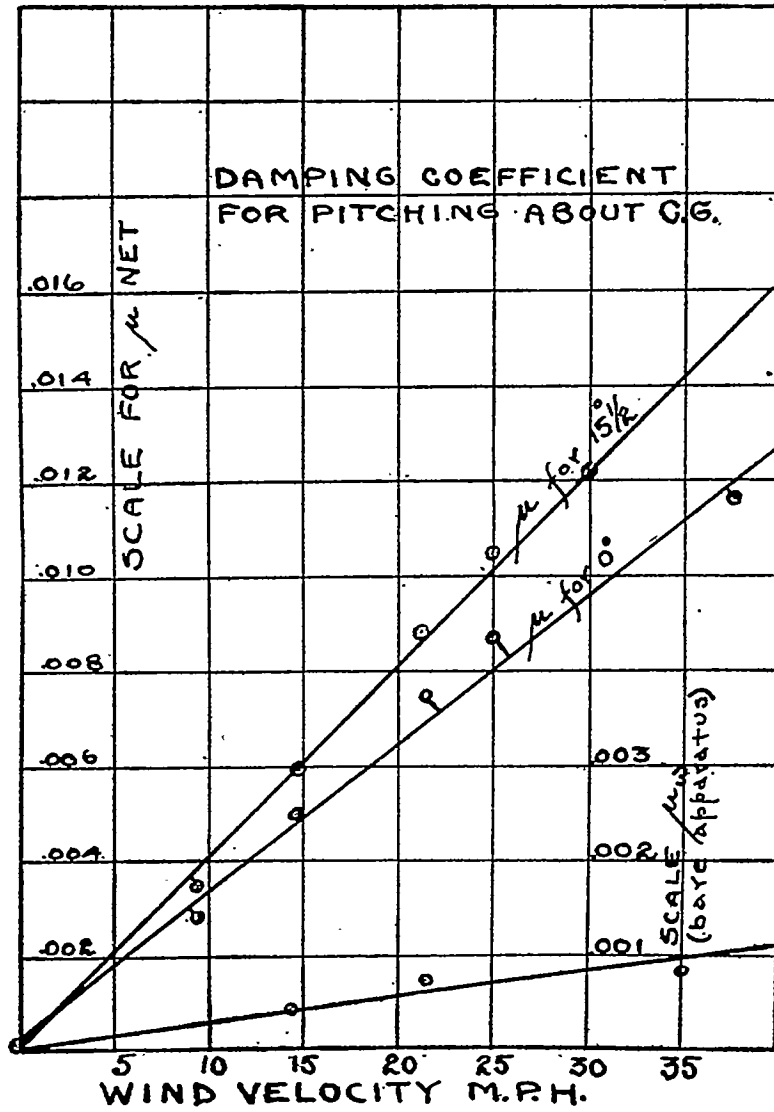

PITCHING OSCILLATION TESTS.

I model and apparatus=0.04195
I apparatus = .0368

Apparatus.

Wind velocity, miles....	0	14.7	21.4	35
n beats counted.....	350	253	210	186
t seconds.....	168	120	100	90
μ00096	.00135	.00162	.00180
μ_w (less zero).....	0	.00039	.00066	.00084

Use faired values below.

Apparatus and model with wing chord 1° to wind.

V miles.....	0	9.5	14.7	21.3	25	30	37.3
n beats.....	300	90	56	40	35	32	27
t seconds.....	180	45	28.5	20	17.5	16	13.5
μ gross.....	.00115	.00410	.00646	.0092	.0105	.0115	.0137
μ_o friction.....	.00096	.00096	.00096	.0010	.0010	.0010	.0010
μ_w apparatus.....	0	.00035	.00040	.0006	.0007	.0009	.0011
μ_m net.....	.00019	.00284	.0054	.0076	.0088	.0096	.0117

But $\mu_m = -m M_q$ when reduced to full size and 79 miles per hour and mass of 55.9 slugs.

$$\therefore M_q = -.0096 \times (24)^4 \times (79/30) \times 1/55.9 = -150.0$$

or for

$$U = -114 \text{ foot-seconds, } M_q = 1.32 U$$

Apparatus and model with wing chord 15.5° to wind.

V.....	9.1	14.7	21.4	25	30	37.5
n.....	75	50	35	30	25	19
t.....	38.5	25.0	17.5	15	13	9
μ gross.....	.0048	.0074	.0105	.0123	.0142	.0205
μ_m net.....	.0035	.0060	.0089	.0106	.0123	.0184

$$M_q = -.0123 \times (24)^4 \times (43.7/30) \times 1/55.9 = -106$$

of

$$M_q = 1.66 U \text{ where } U \text{ is } -64 \text{ foot-seconds, or } 43.7 \text{ miles.}$$

The computed values of μ_m , the model damping coefficient, are plotted on figure 11. It appears that μ_m is approximately a linear function of the velocity, as would be expected, and the conversion to full scale, full speed, is made as indicated above.

The damping coefficient is not greatly different for different attitudes, and the following values are obtained by interpolation:

Angle of wing chord to wind.	V.	U.	M_q .
+1°	79.0	-115.5	1.30 U = -150
7°	51.8	-75.8	1.49 U = -113
10°	47.0	-68.8	1.55 U = -108
12°	45.2	-66.2	1.59 U = -106
14°	44.2	-64.8	1.63 U = -106
15.5°	43.7	-64.0	1.66 U = -106

ARTICLE 11.

RADIUS OF GYRATION.

For the radii of gyration of the fully loaded aeroplane we are indebted to Dr. A. F. Zahm. The actual aeroplane, complete with gasoline, water, pilot, passenger, and other weights in place, was suspended from a beam by a chain. The center of gravity was first located by an inclining method. The machine was then made to oscillate in pitch about the point of attachment of the upper end of the chain. Light guys were run to tail and wing tips to insure that the chain and aeroplane moved as a rigid body.

Let the distance from center of gravity to point of suspension be denoted by h , p the natural period of oscillation in seconds, K_B the radius of gyration in feet about the Y axis or axis of pitch, then

$$K_B^2 = \left(\frac{gh}{4\pi^2} \right) p^2 - h^2$$

By observation $h = 12.2$ feet, $p = 60/14$ seconds.

$$K_B^2 = 34, \quad K_B = 5.8 \text{ feet.}^1$$

ARTICLE 12.

ROUTH'S DISCRIMINANT.

Bryan² has shown that the character of the longitudinal motion of an aeroplane may be investigated with reference to the roots of a biquadratic equation of the form:

$$A\lambda^4 + B\lambda^3 + C\lambda^2 + D\lambda + E = 0$$

The equations of motion may be considered of the form $\theta = Ke^{\lambda t}$ where K is some constant. For stability the quantity λ must be negative if real, or have its real part negative if complex, in order that the amplitude of the motion will diminish with time.

The condition that the real roots and real parts of imaginary roots of a biquadratic equation with constant coefficients shall be negative is that the coefficients A, B, C, D, E shall each be positive as well as the quantity $BCD - AD^2 - B^2E$. The latter is commonly known as Routh's³ discriminant.

The constant coefficients A, B, C, D, E , are functions of the constants of the aeroplane at the normal flying attitude, i. e., the following: $X_u, X_w, X_q, Z_u, Z_w, Z_q, M_u, M_w, M_q, U$, and K_B^2 . These are resistance and rotary derivatives, velocity, and radius of gyration. For a given attitude and for small oscillations about that attitude, it is considered that these quantities are constant. For simplicity it is here assumed that normal flight takes place in a horizontal plane and the inclination of the flight path and consequent components of gravity in the axes of X and Z are eliminated. Also X_q and Z_q are

¹ It is of interest to note that the radius of gyration for rolling was estimated to be 6.2 feet.

² Stability in Aviation.

³ Advanced Rigid Dynamics, E. J. Routh.

neglected as unimportant and M_u is zero by the conditions of equilibrium. For the computation of Routh's discriminant we require to know, then, only those quantities which have been so far determined, and which are assembled below for the different cases investigated.

Formulae for the coefficients A, B, C, D, E are given by Bairstow and are used here, but making $\Theta, X_q, Z_q,$ and M_u zero. They are copied in simplified form for reference.

$$A = K_S^2$$

$$B = -(M_q + X_u K_S^2 + Z_w K_S^2)$$

$$C = \begin{vmatrix} Z_w & U \\ M_w & M_q \end{vmatrix} + X_u M_q + K_S^2 \begin{vmatrix} X_u & X_w \\ Z_u & Z_w \end{vmatrix}$$

$$D = - \begin{vmatrix} X_u & X_w & 0 \\ Z_u & Z_w & U \\ M_u & M_w & M_q \end{vmatrix}$$

$$E = -g M_w Z_u$$

ARTICLE 13.

BAIRSTOW'S APPROXIMATE SOLUTION.

From consideration of the usual relative numerical values of the coefficients of the biquadratic, Bairstow has shown that the equation may be factored to a first approximation and put into the following form:

$$\left(\lambda^2 + B/A \lambda + C/A \right) \left(\lambda^2 + \left[D/C - \frac{BE}{C^2} \right] \lambda + \frac{E}{C} \right) = 0.$$

in which the first factor represents a very short oscillation, which in most aeroplanes rapidly dies out and is of no importance. The second factor represents a relatively long oscillation involving an undulatory flight path with changes in pitch, forward speed, and altitude. The long oscillations should diminish in amplitude with time, in which case the motion is stable and the aeroplane will return to its original normal flight attitude if temporarily deviated therefrom by accidental cause. The motion is unstable if the long oscillation increases in amplitude with time. It will be shown that the aeroplane under investigation is stable at high speeds and unstable at very low speeds. It is believed that this is true of all aeroplanes.

CASE I.

i =incidence, wing chord to wind $+1^\circ$.

Velocity $V=79$ miles. $U=-115.5$ foot-seconds.
 $m=55.9$ slugs, $K_S^2=34$.

$$\begin{array}{lll} X_u = .128 & X_w = .162 & M_w = 1.74 \\ Z_u = -.557 & Z_w = -3.95 & M_q = -150 \end{array}$$

$$\left. \begin{array}{l} A = +34 \\ B = +289 \\ C = +834 \\ D = +115 \\ E = +31 \end{array} \right\} BCD - AD^2 - B^2E = +18 \times 10^6 \text{ stable.}$$

$$\text{Short oscillation: } \lambda^2 + 8.5\lambda + 24.5 = 0$$

$$\lambda = -4.25 \pm 2.54i$$

$$p = \text{period} = \frac{2\pi}{2.54} = 2.5 \text{ seconds.}$$

$$t = \text{time to damp 50 per cent} = \frac{0.69}{4.25} = .16 \text{ second.}$$

$$\text{Long oscillation: } \lambda^2 + .125\lambda + .0374 = 0$$

$$\lambda = -.063 \pm .183i$$

$$p = 34.3 \text{ seconds, } t = 10.8 \text{ seconds.}$$

The short oscillations are unimportant. The long oscillations are easy and strongly damped. The aeroplane should be very steady at this speed.

CASE II.

$$i = 7^\circ, V = 51.8 \text{ miles, } U = -75.9 \text{ foot-seconds.}$$

$$\begin{array}{lll} X_u = .121 & X_w = .113 & M_w = 2.45 \\ Z_u = .849 & Z_w = 2.26 & M_q = 113 \end{array}$$

$$\left. \begin{array}{l} A = + 34.0 \\ B = + 194.0 \\ C = + 467.0 \\ D = + 64.3 \\ E = + 67.0 \end{array} \right\} BCD - AD^2 - B^2E = +32 \times 10^5 \text{ stable.}$$

$$\text{Short oscillation: } \lambda^2 + 5.7\lambda + 15.9 = 0$$

$$\lambda = -2.85 \pm 2.33i$$

$$p = 2.7 \text{ seconds}$$

$$t = .24 \text{ second to damp 50 per cent.}$$

$$\text{Long oscillation: } \lambda^2 + .078\lambda + .143 = 0$$

$$\lambda = -.039 \pm .377i$$

$$p = 16.7 \text{ seconds}$$

$$t = 17.7 \text{ seconds to damp 50 per cent.}$$

The period is shorter than at high speed and the damping less. The aeroplane should therefore be less comfortable.

CASE III.

$$i = 10^\circ, V = 47 \text{ miles, } U = -68.8 \text{ foot-seconds.}$$

$$\begin{array}{lll} X_u = .151 & Z_u = .936 & M_w = 2.50 \\ X_w = .075 & Z_w = 1.46 & M_q = 108 \end{array}$$

$$\left. \begin{array}{l} A = + 34 \\ B = + 165 \\ C = + 355 \\ D = + 42.5 \\ E = + 75.3 \end{array} \right\} BCD - (AD^2 + B^2E) = 3.8 \times 10^5 \text{ stable.}$$

$$\text{Short oscillation: } \lambda^2 + 4.85\lambda + 10.44 = 0$$

$$\lambda = -2.42 \pm 2.12i$$

$$p = 2.96 \text{ seconds.}$$

$$t = .28 \text{ second to damp 50 per cent.}$$

$$\text{Long oscillation: } \lambda^2 + .021\lambda + .212 = 0$$

$$\lambda = -.011 \pm .460i$$

$$p = 13.71 \text{ seconds.}$$

$$t = 62.7 \text{ seconds to damp 50 per cent.}$$

This oscillation is rapid and but slightly damped, and would probably be uncomfortable. The stability is slight and wind gusts or external disturbances, if recurrent, might cause trouble.

CASE IV.

$i=12^\circ$, $V=45.2$ miles $U=-66.2$ foot-seconds.

$$\begin{array}{l} X_u-.189 \quad Z_u-.972 \quad M_p+2.15 \\ X_w-.236 \quad Z_w-.736 \quad M_q-106 \end{array}$$

$$\left. \begin{array}{l} A=+34 \\ B=+137.5 \\ C=+243 \\ D=+17.4 \\ E=+67.2 \end{array} \right\} BCD-AD^2-B^2E=-7 \times 10^5 \text{ UNSTABLE.}$$

Short oscillation: $\lambda^2+4.04\lambda+7.14=0$
 $\lambda=-2.02 \pm 1.75i$

$p=3.59$ seconds
 $t=.342$ second to damp 50 per cent.

Long oscillation: $\lambda^2-.985\lambda-.276=0$
 $\lambda=+.043 \pm .524i$

$p=12.0$ seconds.
 $t=16.0$ seconds to double amplitude.

The machine is frankly unstable and the pilot dare not release his elevator control.

CASE V.

$i=14^\circ$, $V=44.2$ miles, $U=-64.8$ foot-seconds.

$$\begin{array}{l} X_u-.223 \quad Z_u-.993 \quad M_p+1.99 \\ X_w-.132 \quad Z_w-.553 \quad M_q-106 \end{array}$$

$$\left. \begin{array}{l} A=+34 \\ B=+134 \\ C=+213 \\ D=+28 \\ E=+63.6 \end{array} \right\} BCD-AD^2-B^2E=-3.7 \times 10^5 \text{ UNSTABLE.}$$

CASE VI.

$i=15.5^\circ$ $V=43.7$ miles, $U=-63.8$ foot-seconds.

$$\begin{array}{l} X_u-.276 \quad Z_u-1.01 \quad M_p+2.02 \\ X_w-.292 \quad Z_w-.673 \quad M_q-106 \end{array}$$

$$\left. \begin{array}{l} A=+34 \\ B=+138 \\ C=+226 \\ D=+24.2 \\ E=+65.7 \end{array} \right\} BCD-AD^2-B^2E=-5 \times 10^5 \text{ UNSTABLE.}$$

Short oscillation: $\lambda^2+4.06\lambda+6.65=0$
 $\lambda=-2.03 \pm 1.59i$

$p=3.95$ seconds, period.
 $t=.34$ seconds to damp 50 per cent.

Long oscillation: $\lambda^2+.071\lambda+.291=0$
 $\lambda=+.0358 \pm .541i$

Real part of λ is here positive, indicating an oscillation increasing with time.

$$p = \frac{2\pi}{.541} = 11.6 \text{ seconds.}$$

$$t = \frac{.069}{.0358} = 19.3 \text{ seconds to double amplitude.}$$

The motion is both rapid in period and rapidly increasing in amplitude. Indeed the amplitude is doubled in two swings. This aeroplane, if left to itself, would be highly unstable.

ARTICLE 14.

VARIATION OF LONGITUDINAL STABILITY WITH SPEED.

Preliminary to consideration of the action of gusts on an inherently stable aeroplane, it was desired to analyze the motion in still air of a machine which could be called inherently stable longitudinally. It has been found above that a typical aeroplane becomes less stable at low speeds until real instability results. This result is somewhat unexpected in view of the curves of pitching moment M , which indicated static stability at all possible attitudes up to and including horizontal flight at $+15^\circ.5$. In other words, M_w is positive for all cases. The instability comes about on account of the rapid rate of increase of drift at large angles causing X_w to change sign, and on account of the less rapid rate of increase of lift, causing Z_w to become small at high angles of pitch. Furthermore, M_q diminishes at low speed.

From the speed power curves on figure 3, it appears that for angles greater than 10° , we are on the part of the power curve which requires more power to go slower, "region of reversed controls." This region is now found to be dynamically unstable so that controlled flight only is possible here. But with reversed controls this is doubly dangerous.

The frequency of accidents at low speeds, following the recent demand for a wide speed range, confirms this impression of the danger of low speeds when approaching a critical angle and speed. The critical angle for instability is clearly an angle less than the possible maximum for flight.

A fair measure of the relative stability at various speeds may be had by noting the following tabulation of the values of Routh's discriminant, denoted by R :

Velocity in miles.	Wind chord to wind.	R .
79.0	1°	$+180 \times 10^5$
51.8	7°	$+32 \times 10^5$
47.0	10°	$+3.8 \times 10^5$
45.2	12°	-7×10^5
44.2	14°	-3.7×10^5
43.7	15.5°	-5×10^5

The table is reproduced graphically on figure 12.

A similar investigation for lateral stability fails to show any marked change with speed, as would be expected since speed depends on pitch angle and the factors which make or unmake lateral stability are but slightly affected by angle of pitch.

FIG. 12.

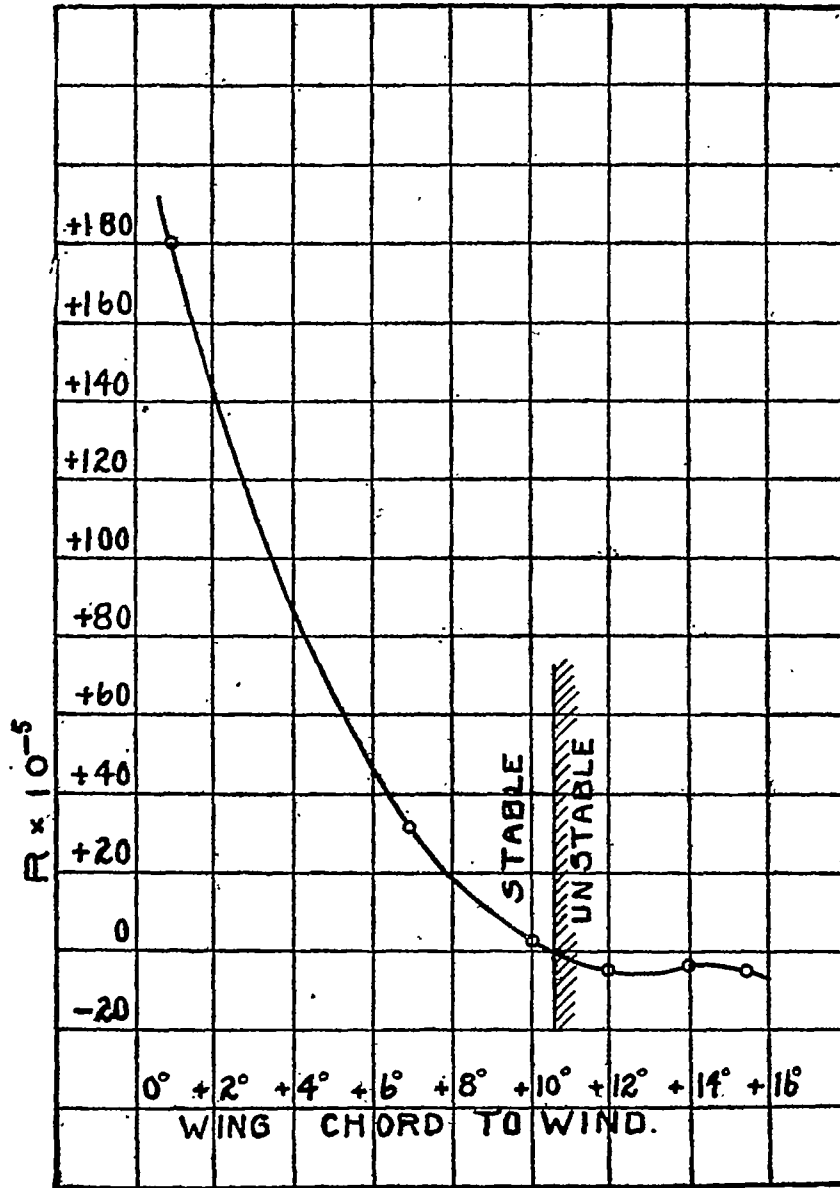

ROUTH'S DISCRIMINANT,
VARIATION WITH ATTITUDE.

REPORT No. 1.

PART 2.

THEORY OF AN AEROPLANE ENCOUNTERING GUSTS.

By EDWIN BIDWELL WILSON.

ARTICLE 1.

INTRODUCTION.

The notation here used will be in the main that of Bairstow. (Technical Report of the Committee for Aeronautics for the Year 1912-13, p. 143.) As, however, Bairstow changes his notation in the first few pages of his report, we shall begin at the start with some departures from him.

If x, y, z are moving axes directed, respectively, backward, to the left, and upward relative to the driver; if u', v', w' be linear velocities, and p', q', r' be angular velocities, resolved along these axes; and if X', Y', Z' be forces, and L', M', N' be moments of forces (measured per unit mass of the aeroplane); then the dynamical equations of motion are

$$du'/dt + w'q' - v'r' = X', \quad (1a)$$

$$dv'/dt + u'r' - w'p' = Y', \quad (1b)$$

$$dw'/dt + v'p' - u'q' = Z', \quad (1c)$$

$$dh_1/dt - r'h_2 + q'h_3 = mL', \quad (2a)$$

$$dh_2/dt - p'h_3 + r'h_1 = mM', \quad (2b)$$

$$dh_3/dt - q'h_1 + p'h_2 = mN', \quad (2c)$$

where m is the mass and

$$h_1 = p'A - q'F - r'E, \quad (3a)$$

$$h_2 = q'B - r'D - p'F, \quad (3b)$$

$$h_3 = r'C - p'E - q'D, \quad (3c)$$

are the components of angular momentum,—the quantities A, B, C being the moments and D, E, F the products of inertia relative to the moving axes fixed in the body.

The symmetric aeroplane will alone be considered here;

$$D - F = 0. \quad (4)$$

If the machine is in uniform horizontal flight, all the forces, moments, linear velocities and angular velocities except u' vanish, and $u' = U$, a negative quantity in magnitude equal to the uniform velocity. (The precise backward direction of the x -axis is that which is horizontal in uniform flight, and hence by this definition the direction of this axis, and of the z -axis, varies in the aeroplane with the speed.)

If the motion is slightly disturbed, the velocities take the values

$$u' = U + u, v' = v, w' = w, p' = p, q' = q, r' = r, \quad (5)$$

where u, v, w, p, q, r are small. The products of these small quantities are neglected, as in all discussions of small oscillations, and the equations take the form

$$du/dt = X', \quad dv/dt + Ur = Y', \quad dw/dt - Uq = Z', \quad (6)$$

$$Adp/dt - Edr/dt = mL', \quad Bdq/dt = mM', \quad Cdr/dt - Edp/dt = mN'. \quad (7)$$

In uniform motion the forces and moments all vanish. For the disturbed motion they are small and may be expressed linearly in terms of u, v, w, p, q, r . The forces are due to three sources: 1° the propeller thrust, 2° gravity, 3° the air. We shall assume that the propeller thrust (and moment, if any, arising from it) is constant; i. e., the motor is supposed to speed up or slow down under changed conditions so as to deliver a constant thrust. If θ and φ are the small pitch and roll, the components of gravity are $g\theta, -g\varphi, -g$ (see Bairstow, 144, $7u - w$), and its moments are zero because the C. G. is taken as origin. The air forces and moments may be written as X, Y, Z, L, M, N and developed as

$$X = X_0 + X_u u + X_v v + X_w w + X_p p + X_q q + X_r r, \quad (8)$$

where X_u, X_v, \dots are the "resistance derivatives" taken for the relative velocity of machine and wind. (X_0 and the propeller thrust cancel, so do Z_0 and g ; Y_0, L_0, M_0, N_0 vanish.)

In the symmetric aeroplane half the resistance derivatives vanish and the six equations of motion separate into two sets of three each, one set for the longitudinal, the other for the transverse motion. These equations are (Bairstow, 148, 13 and 14 with $\Theta = 0$) for longitudinal motion,

$$du/dt = g\theta + X_u u + X_w w + X_q q, \quad (9a) \text{ see (1a)}$$

$$dw/dt = Uq + Z_u u + Z_w w + Z_q q, \quad (9b) \text{ see (1c)}$$

$$B/m \cdot dq/dt = M_u u + M_w w + M_q q, \quad (9c) \text{ see (2b)}$$

and, for transverse motion,

$$dv/dt = -g\varphi - Ur + Y_v v + Y_p p + Y_r r, \quad (10a) \text{ see } (1b)$$

$$A/m \cdot dp/dt - E/m \cdot dr/dt = L_v v + L_p p + L_r r, \quad (10b) \text{ see } (2a)$$

$$C/m \cdot dr/dt - E/m \cdot dp/dt = N_v v + N_p p + N_r r. \quad (10c) \text{ see } (2c)$$

The integration of these equations gives the free oscillations of the aeroplane.

ARTICLE 2.

LONGITUDINAL MOTION IN SMALL GUSTS.

A gust if not too severe may be treated by the method of forced oscillations. If the aeroplane is traveling on an irregular wind, we may regard the average wind velocity relative to the machine as that which should be used in the computation of the resistance derivatives, and we may regard the departures of the actual relative velocity from the mean as small quantities inducing additional forces into the equations of motion.

Suppose first a head-on gustiness. This would introduce an extra term of the form $X_u u$ into the first equation, $Z_u u$ in the second, and so on. If, as a result of the gust, the machine tilted appreciably, the originally head-on gust would no longer be head-on, but would have components u_1, w_1 and give rise to the term $X_u u_1 + X_w w_1$ in the first equation. It is clear, however, that under the hypothesis of small oscillations, w_1 would remain small of the second order relative to u_1 . The term $X_w w_1$ could then be neglected relative to $X_u u_1$, unless X_w much exceeded X_u .

We should in general allow a gust to have components $u_1, v_1, w_1, p_1, q_1, r_1$ relative to the axes. This would take into account any possible rotational motion in the gust. The rotational motion of a gust may be quite small. In the discussion by Glazebrook (*Aeronautical Journal*, July, 1914, pp. 272-301) nothing is accomplished relative to rotational gusts. Yet it may well be that the rotational element is of great importance. For the rotary derivatives, in the case of the machine whose derivatives are tabulated by Bairstow (*loc. cit.*, 159), are large. Thus a term $M_q q_1 = -210q_1$ would be comparable with $X_u u_1 = -0.14u_1$ if q_1 were 1/700 of u_1 ; i. e., if the gust were a uniform whirl of radius 700 feet. In the same way L_p is large. In the machine that will be discussed in what follows M_q is also large, viz., -150.

The equations for the longitudinal motion in a general gust are (see 9a-c)

$$du/dt - g\theta - X_u u - X_w w - X_q q = X_u u_1 + X_w w_1 + X_q q_1. \quad (11a)$$

$$dw/dt - Uq - Z_u u - Z_w w - Z_q q = Z_u u_1 + Z_w w_1 + Z_q q_1. \quad (11b)$$

$$B/m \cdot dq/dt - M_u u - M_w w - M_q q = M_u u_1 + M_w w_1 + M_q q_1. \quad (11c)$$

The solution of these equations consists of two parts: 1° the so-called complementary function which gives the natural oscillations, 2° the particular integral which gives the forced oscillations due to the gust. To effect a solution for the particular integral, we must

make some assumption as to the value of the components u_1 , w_1 , q_1 of the gusts as functions of the time. Before making such an assumption for the particular integral, the solution by the "operational" method may be indicated. (See Wilson, Advanced Calculus, p. 223.)

Let D denote differentiation. The equations may be written

$$(D - X_u)u - X_w w - (X_q D + g)\theta = X_u u_1 + X_w w_1 + X_q q_1, \quad (12a)$$

$$-Z_u u + (D - Z_w)w - (Z_q + U)D\theta = Z_u u_1 + Z_w w_1 + Z_q q_1, \quad (12b)$$

$$-M_u u - M_w w + (k^2_B D^2 - M_q D)\theta = M_u u_1 + M_w w_1 + M_q q_1, \quad (12c)$$

where $k^2_B = B/m$. These equations are solved algebraically by multiplying by the proper cofactor determinants and adding. Then

$$\begin{aligned} D \begin{vmatrix} -X_u & -X_w & -(X_q D + g) \\ -Z_u & D - Z_w & -(Z_q + U)D \\ -M_u & -M_w & k^2_B D^2 - M_q D \end{vmatrix} u = & \begin{vmatrix} X_u & -X_w & -(X_q D + g) \\ Z_u D - Z_w & - & -(Z_q + U)D \\ M_u & -M_w & k^2_B D^2 - M_q D \end{vmatrix} u_1 \\ & + \begin{vmatrix} X_w & -X_w & -(X_q D + g) \\ Z_w D - Z_w & - & -(Z_q + U)D \\ M_w & -M_w & k^2_B D^2 - M_q D \end{vmatrix} w_1 \\ & + \begin{vmatrix} X_q & -X_w & -(X_q D + g) \\ Z_q D - Z_w & - & -(Z_q + U)D \\ M_q & -M_w & k^2_B D^2 - M_q D \end{vmatrix} q_1 \end{aligned} \quad (13)$$

or, if the determinant on the left be denoted by Δ ,

$$\begin{aligned} \Delta u = & \begin{vmatrix} X_u & -X_w & -(X_q D + g) \\ Z_u D - Z_w & - & -(Z_q + U)D \\ M_u & -M_w & k^2_B D^2 - M_q D \end{vmatrix} u_1 \\ & + D \begin{vmatrix} X_w & - & (X_q D + g) \\ M_w & k^2_B D^2 - M_q D & \end{vmatrix} w_1 + \begin{vmatrix} X_q & -X_w & -g \\ Z_q D - Z_w & -UD & \\ M_q & -M_w & k^2_B D^2 \end{vmatrix} q_1. \end{aligned} \quad (14a)$$

There are similar equations for w and θ , namely,

$$\Delta w = \begin{vmatrix} D - X_u X_w & - & (X_q D + g) \\ -Z_u Z_w & - & (Z_q + U)D \\ -M_u M_w & & k^2_B D^2 - M_q D \end{vmatrix} w_1 \quad (14b)$$

$$+ D \begin{vmatrix} Z_u & -(Z_q + U)D \\ M_u & k^2_B D^2 - M_q D \end{vmatrix} u_1 + \begin{vmatrix} D - X_u X_q & -g \\ -Z_u Z_q & -UD \\ -M_u M_q & k^2_B D^2 \end{vmatrix} q_1$$

$$\Delta \theta = \begin{vmatrix} D - X_u & -X_w & X_q \\ -Z_u & D - Z_w & Z_q \\ -M_u & -M_w & M_q \end{vmatrix} q_1 \quad (14c)$$

$$+ D \begin{vmatrix} D - Z_w Z_u \\ -M_w M_u \end{vmatrix} u_1 + D \begin{vmatrix} D - X_u X_w \\ -M_u M_w \end{vmatrix} w_1.$$

The general (literal) integration of these equations would be so complicated as to be useless. We shall make use of the formulas only after simplification by the insertion of numerical data.

Possible methods of treating gusts.—The only treatment of gusts which I have seen is that described somewhat popularly by Glazebrook (loc. cit.). He seems to state, as the main method of attack, that of small differences whereby it is assumed that the involved time over which the motion is to be studied is divided into small parts, and that the atmospheric conditions remain constant during each of these parts. By then regarding the differential equations of motion as equations in differences of the following form,

$$\Delta u' = (X' - w'q' + v'r')\Delta t, \text{ etc.},$$

$$\Delta h_1 = (mL' + r_2'h_2 - q'h_3)\Delta t, \text{ etc.},$$

it is possible to compute, through a series of intervals Δt , the approximate positions of the aeroplane. This method is, as Glazebrook states, exceedingly tedious, for Δt must be taken very small, indeed only a small part of a second in the case of a sharp gust, in order that the solution may be even approximately satisfactory for the differential equations. Moreover, the whole calculation apparently has to be done from the beginning for each new type of gust which one desires to study. The method, however, is applicable in all generality irrespective of the stability of the aeroplane.

The reason that I have chosen to operate on the basis of small oscillations is that after a certain amount of preliminary calculation has been accomplished my formulas will enable me to treat very rapidly a series of very different types of gusts. My method is not applicable, of course, to machines which are not stable, for the oscillations could not remain small with such machines, but it is probably doubtful whether the motion of the unstable aeroplane in a gusty wind is of very great importance, as the instability of the machine is not unlikely to cause indeterminately violent motions on relatively small gusts. I have tried to devise methods which would enable me to use graphical apparatus for obtaining the solutions here desired, but have been unable to throw the equations into a form which lends itself to such methods.

Moreover, the coefficients which enter into the equations and into the solutions at all stages of the work are of such varying magnitudes that it is difficult to obtain any reasonably accurate results. It seems impossible—I have not yet succeeded in avoiding the difficulty—to eliminate the occasional necessity of subtracting numbers which are nearly equal in magnitude; thus the accuracy of the figures is, after subtraction, seriously impaired. As I was aware that the data furnished me were probably not accurate to three figures, I first made the calculations with slide-rule accuracy, only to find that the final results became wholly illusory, owing to the difficulty just mentioned. I have therefore had to recompute everything with 4-place logarithm tables. Most of the figures which occur in the work are therefore 4-place numbers. Those which appear to have only three significant figures generally have the fourth figure zero when occurring in formulas containing 4-place numbers. In the calculations toward the end of the research the 4-figure accuracy has become reduced to three or two figure accuracy, but it did not seem best systematically to reduce the numbers by the omission of two figures, although this reduction has occasionally been made in final calculations.

ARTICLE 3.

NUMERICAL EQUATIONS FOR HIGH SPEED.

The data for high speed are (see Hunsaker, p. 47):

$$\begin{aligned} X_u &= -0.128, & X_w &= +0.162, & X_q &= 0 \\ Z_u &= -0.557, & Z_w &= -3.95, & Z_q &= 0 \\ M_u &= 0, & M_w &= +1.74, & M_q &= -150 \\ B/m = k^2_B &= 34, & U &= -115.5, & g &= 32.17 \end{aligned} \quad (15)$$

The cofactors δ in the determinant Δ are—

$$\begin{aligned} \begin{vmatrix} D - Z_w & -(Z_q + U)D \\ -M_w & k^2_B D^2 - M_q D \end{vmatrix} &= \begin{vmatrix} D + 3.95 & 115.5D \\ -1.74 & 34D^2 + 150D \end{vmatrix} \\ &= 34D^3 + 284.3D^2 + 793.5D = \delta_{11} \end{aligned}$$

$$\begin{aligned} \begin{vmatrix} -M_w & k^2_B D^2 - M_q D \\ -X_w & -(X_q D + g) \end{vmatrix} &= \begin{vmatrix} -1.74 & 34D^2 + 150D \\ -0.162 & -32.17 \end{vmatrix} \\ &= 5.508D^2 + 24.30D + 55.98 = \delta_{21} \end{aligned}$$

$$\begin{aligned} \begin{vmatrix} -X_w & -(X_q D + g) \\ D - Z_w & -(Z_q + U)D \end{vmatrix} &= \begin{vmatrix} -0.162 & -32.17 \\ D + 3.95 & 115.5D \end{vmatrix} \\ &= 13.46D + 127.1 = \delta_{31} \end{aligned}$$

$$\begin{aligned} \begin{vmatrix} -(Z_q + U)D & -Z_u \\ k^2_B D^2 - M_q D & -M_u \end{vmatrix} &= \begin{vmatrix} 115.5D & 0.557 \\ 34D^2 + 150D & 0 \end{vmatrix} \\ &= -18.94D^2 - 83.56D = \delta_{12} \end{aligned}$$

$$\begin{aligned} \begin{vmatrix} D - X_u & -(X_q D + g) \\ -M_u & k^2_B D^2 - M_q D \end{vmatrix} &= \begin{vmatrix} D + 0.128 & -32.17 \\ 0 & 34D^2 + 150D \end{vmatrix} \end{aligned}$$

$$\begin{aligned} &= 34D^3 + 154.3D^2 + 19.20D = \delta_{22} \\ \begin{vmatrix} -(X_q D + g) & D - X_u \\ -(Z_q + U)D & -Z_u \end{vmatrix} &= \begin{vmatrix} -32.17 & D + 0.128 \\ 115.5D & 0.557 \end{vmatrix} \\ &= -115.5D^2 - 14.78D - 17.92 = \delta_{32} \end{aligned}$$

$$\begin{aligned} \begin{vmatrix} -Z_u & D - Z_w \\ -M_u & -M_w \end{vmatrix} &= \begin{vmatrix} -0.557 & D + 3.95 \\ 0 & -1.74 \end{vmatrix} \\ &= -0.9692 = \delta_{13} \end{aligned}$$

$$\begin{aligned} \begin{vmatrix} -X_w & D - X_u \\ -M_w & -M_u \end{vmatrix} &= \begin{vmatrix} -0.162 & D + 0.128 \\ -1.74 & 0 \end{vmatrix} \\ &= 1.74D + .2227 = \delta_{23} \end{aligned}$$

$$\begin{aligned} \begin{vmatrix} D - X_u & -X_w \\ -Z_u & D - Z_w \end{vmatrix} &= \begin{vmatrix} D + 0.128 & -0.162 \\ 0.557 & D + 3.95 \end{vmatrix} \\ &= D^2 + 4.078D + .5957 = \delta_{33} \end{aligned}$$

The value of the determinant Δ is

$$\begin{aligned} 34D + 288.7D^2 + 833.0D^3 + 115.1D + 31.18 = \\ 34(D^4 + 8.490D^3 + 24.50D^2 + 3.385D + 0.9170). \end{aligned}$$

(The value of the determinant checks by three calculations.)
The roots of the equation

$$f(D) = D^4 + 8.49D^3 + 24.5D^2 + 3.385D + 0.917 = 0 \quad (16)$$

determine the decrements and periods of the natural oscillations, and must be found. (Unfortunately these roots must be found with considerable accuracy, and the rough first approximations, such as are indicated by Bairstow, seem insufficient for our use.) Let it be assumed that one root is so large that it may be found approximately from

$$D^4 + 8.49D^3 + 24.5D^2 = D^2 + 8.49D + 24.5 = 0.$$

Then $D = -4.245 \pm 2.545i$.

If now r be an approximate solution of $f(D) = 0$, a new approximation may be had by assuming $r + x$, with x small, as a root.

Then

$$x = -\frac{f(r)}{f'(r)} = -\frac{r^4 + 8.49r^3 + 24.5r^2 + 3.385r + 0.917}{4r^3 + 25.47r^2 + 49r + 3.385}$$

approximately. As $r^2 + 8.49r + 24.5 = 0$, the fraction simplifies to

$$x = -\frac{3.385r + 0.917}{23.08r + 211.4} = .063 + .107i,$$

if $r = -4.245 - 2.545i$. This root of $f(D) = 0$ is therefore

$$D = -4.182 \pm 2.438i.$$

The factor of $f(D)$ corresponding to this pair of roots is

$$D^2 + 8.364D + 23.43. \quad (17a)$$

Let the other factor be $D^2 + aD + b$. Then $23.43b = 0.917$ and $b = .03914$. Also, $8.364(.0391) + 23.43a = 3.385$ or $23.43a = 3.058$ and $a = .1305$. Hence the second factor is

$$D^2 + .1305D + .03914. \quad (17b)$$

As a check on the work we may multiply the two factors together; we find

$$(D^2 + 8.364D + 23.43)(D^2 + .1305D + .03914) = D^4 + 8.494D^3 + 24.56D^2 + 3.385D + .9170.$$

We can find, merely by careful trial, better factors as

$$(D^2 + 8.359D + 23.37)(D^2 + .1308D + .03924) = D^4 + 8.490D^3 + 24.50D^2 + 3.385D + .9170. \quad (18)$$

The definitive roots of $f(D) = \Delta = 0$ may therefore be taken as

$$\begin{aligned} a &= -4.180 - 2.430i, & b &= -4.180 + 2.430i \\ c &= -.0654 - .1870i, & d &= -.0654 + .1870i \end{aligned} \quad (19)$$

ARTICLE 4.

INTEGRATION FOR HIGH SPEED.

The numerical equation for u is (see 14a):

$$\begin{aligned}
 & 34 (D^4 + 8.49 D^3 + 24.5 D^2 + 3.385 D + 0.917) u \\
 & = (X_u \delta_{11} + Z_u \delta_{31}) u_1 + D \delta_{22} w_1 + M_q \delta_{31} q_1 \\
 & = -34 (0.128 D^3 + 1.160 D^2 + 3.385 D + 0.917) u_1 \quad (20a) \\
 & + 34 D (0.162 D^2 + 0.715 D + 1.647) w_1 \\
 & - 34 (59.37 D + 560.6) q_1.
 \end{aligned}$$

The numerical equation for w is (see 14b):

$$\begin{aligned}
 & 34 (D^4 + 8.49 D^3 + 24.5 D^2 + 3.385 D + 0.917) w \\
 & = (X_w \delta_{12} + Z_w \delta_{22} + M_w \delta_{32}) w_1 + D \delta_{12} u_1 + M_q \delta_{32} q_1 \\
 & = -34 (3.95 D^3 + 23.94 D^2 + 3.385 D + 0.917) w_1 \quad (20b) \\
 & - 34 D^2 (0.557 D + 2.458) u_1 \\
 & + 34 (509.5 D^2 + 65.21 D + 79.05) q_1.
 \end{aligned}$$

The numerical equation for θ is (see 14c):

$$\begin{aligned}
 & 34 (D^4 + 8.49 D^3 + 24.5 D^2 + 3.385 D + 0.917) \theta \\
 & = M_q \delta_{33} q_1 + D \delta_{13} u_1 + D \delta_{23} w_1 \quad (20c) \\
 & = 34 (4.412 D^2 + 17.99 D + 2.628) q_1 \\
 & - 34 (0.02851) D u_1 + 34 D (0.05117 D + .00655) w_1.
 \end{aligned}$$

The solutions are of the type:

$$\begin{aligned}
 u &= C_{11} e^{at} + C_{12} e^{bt} + C_{13} e^{ct} + C_{14} e^{dt} + I_u, \\
 w &= C_{21} e^{at} + C_{22} e^{bt} + C_{23} e^{ct} + C_{24} e^{dt} + I_w, \quad (21) \\
 \theta &= C_{31} e^{at} + C_{32} e^{bt} + C_{33} e^{ct} + C_{34} e^{dt} + I_\theta,
 \end{aligned}$$

where a, b, c, d are the roots of the biquadratic (see 19), C_{ij} certain constants of integration, and I_u, I_w, I_θ a set of particular solutions of the equations. We shall determine I_u, I_w, I_θ in such a manner that they will not contain the functions e^{at} , etc.; we may therefore determine in advance the relations between the twelve C 's. (This will debar us from using as gusts u_1, w_1, q_1 , those which are of the form Ce^{at} , etc.; but this restriction is not important—such a damped gust tuned to the damping and period of the machine is highly improbable in nature.)

If we substitute u, w, θ in the equations (14), the particular solutions must cancel out among themselves (since they can not cancel terms of the form e^{at}) and leave

$$\begin{aligned}
 & (a - X_u) C_{11} e^{at} - X_w C_{21} e^{at} - (X_q a + g) C_{31} e^{at} + \text{similar terms} = 0, \\
 & -Z_u C_{11} e^{at} + (a - Z_w) C_{21} e^{at} - (Z_q + U) a C_{31} e^{at} + \dots = 0, \\
 & -M_u C_{11} e^{at} - M_w C_{21} e^{at} + (k^2_B D^2 - M_q D) C_{31} e^{at} + \dots = 0.
 \end{aligned}$$

These equations hold identically in t , and the coefficient of e^{at} , etc., in each must vanish. The three homogeneous equations in the three unknowns C_{11} , C_{21} , C_{31} (or the similar equations in C_{12} , C_{22} , C_{32} ; C_{13} , C_{23} , C_{33} ; C_{14} , C_{24} , C_{34}) are consistent because a (or b , c , d) is a root of the determinant Δ , and the solutions are:

$$C_{11}: C_{21}: C_{31} = \begin{vmatrix} -X_w - g \\ a - Z_w - Ua \end{vmatrix} : \begin{vmatrix} -g & a - X_u \\ -Ua & -Z_u \end{vmatrix} : \begin{vmatrix} a - X_u & -X_w \\ -Z_u & a - Z_w \end{vmatrix}$$

with C_{12} , C_{22} , C_{32} determined by the same functions of b . In words: To obtain the ratios of the coefficients of e^{at} in u , v , w , substitute $D = a$ in the determinants δ_{31} , δ_{32} , δ_{33} . Or C_{12} : C_{22} : C_{32} as

$$13.46a + 127.1 : -115.5a^2 - 14.78a - 17.92 : a^2 + 4.078a + .5957$$

or C_{11} : C_{21} : $C_{31} = 13.46a + 127.1 : 950.8a + 2560 : -4.281a - 22.81$.

This gives C_{11} : C_{21} : C_{31} as

$$70.8 - 32.7i : -1414 - 2310i : -4.92 + 10.40i \text{ or as}$$

$$1 : -4.04 - 34.52i : -.1132 + .0946i$$

The values of C_{12} : C_{22} : C_{32} are the conjugates

$$1 : -4.04 + 34.52i : -.1132 - .0946i$$

To find C_{13} : C_{23} : C_{33} we must substitute $c = -.065 - .187i$ in the same determinants. Then

$$C_{13}: C_{23}: C_{33} = 13.46c + 127.1 : .33c - 13.39 : 3.947c + .5565. \text{ This gives}$$

$$C_{13}: C_{23}: C_{33} \text{ as}$$

$$126.2 - 2.516i : -13.37 - .0623i : .2983 - .7380i$$

or $1 : -.1058 - .002587i : .002478 - .005799i$.

The values of the conjugates are:

$$C_{14}: C_{24}: C_{34} = 1 : -.1058 + .002587i : .002478 + .005799i$$

The general solutions of the equation of motion are:

$$u = C_{11}e^{at} + C_{12}e^{bt} + C_{13}e^{ct} + C_{14}e^{dt} + I_u, \quad (22a)$$

$$w = (-4.04 - 34.5i)C_{11}e^{at} + (-4.04 + 34.5i)C_{12}e^{bt} \\ + (-.1058 - .002587i)C_{13}e^{ct} + (-.1058 + .002587i)C_{14}e^{dt} + I_w, \quad (22b)$$

$$\theta = (-.1132 + .0946i)C_{11}e^{at} + (-.1132 - .0946i)C_{12}e^{bt} \\ + (.002478 - .005799i)C_{13}e^{ct} + (.002478 + .005799i)C_{14}e^{dt} + I_\theta. \quad (22c)$$

From these equations we see that the heavily damped short period oscillation (roots a , b) is about $34\frac{1}{2}$ times as strong in w as in u ; whereas the mildly damped long period oscillation (roots c , d) is about $9\frac{1}{2}$ times as effective in u as in w . Moreover, the short period motions in u and w are about quartered; but the long period motions are in opposite phase. The amplitude of the short period motion in θ is about $\frac{1}{240}$ that of w ; hence for each foot-second of short oscillation in w there is about $\frac{1}{2}^\circ$ in θ . The amplitude of the long period motion in θ is about .006 of that in u ; hence for each foot-second of long oscillation in u there is about $\frac{1}{3}^\circ$ in θ . The damping of the short oscillation is so strong that the amplitude is reduced to about one-

ninetieth in one second where in the case of the long oscillation the reduction is only to about nine-tenths of its original value in one second; the relative amplitudes in the cases of u , w , θ are more important in the case of the long than in that of the short period oscillation because the latter is so quickly damped out that the swing may not get well started. However, the extreme magnitude of the short period oscillation in w as compared with u indicates the possibility of relatively violent accelerations in w ; indeed, it is the short period oscillation which may account for initial difficulties whereas the long period oscillation accounts for the progressive troubles, due to gusts.

There remain to be determined the values of the constants C of integration from the initial conditions of uniform flight, i. e., $u=w=\theta=q=0$. Let the particular solutions have the initial values I_{u0} , I_{w0} , $I_{\theta0}$. Then

$$\begin{aligned} 0 &= C_{11} + C_{12} + C_{13} + C_{14} + I_{u0}, \\ 0 &= (-4.04 - 34.5i)C_{11} + (-4.04 + 34.5i)C_{12} \\ &\quad + (-.1058 - .002587i)C_{13} + (-.1058 + .002587i)C_{14} + I_{w0}, \\ 0 &= (-.1132 + .0946i)C_{11} + (-.1132 - .0946i)C_{12} \\ &\quad + (.002478 - .005799i)C_{13} + (.002478 + .005799i)C_{14} + I_{\theta0}, \\ 0 &= (-.1132 + .0946i)aC_{11} + (-.1132 - .0946i)bC_{12} \\ &\quad + (.002478 - .005799i)cC_{13} + (.002478 + .005799i)dC_{14} + I'_{\theta0}, \\ \text{or } 0 &= (.703 - .205i)C_{11} + (.703 + .205i)C_{12} + (-.001246 - .000084i)C_{13} \\ &\quad + (-.001246 + .000084i)C_{14} + I'_{\theta0}. \end{aligned}$$

The values of C_{11} , C_{12} and C_{13} , C_{14} are conjugate imaginaries; hence $C_{11} + C_{12} = A$, $C_{13} + C_{14} = B$, $i(C_{12} - C_{11}) = C$, $i(C_{14} - C_{13}) = D$ are real. The equations may therefore be written

$$\begin{aligned} 0 &= A + B + I_{u0} \\ 0 &= -4.04 A + 34.5 C - .1058 B + .002587 D + I_{w0} \\ 0 &= -.132 A - .0946 C + .002478 B + .005799 D + I_{\theta0} \\ 0 &= .703 A + .205 C - .001246 B + .000084 D + I'_{\theta0}. \end{aligned}$$

The values for A , B , C , D are (as found by determinants and checked by substitution):

$$\begin{aligned} A &= -.0008856 I_{u0} + .008198 I_{w0} + .01621 I_{\theta0} - 1.372 I'_{\theta0}, \\ C &= -.003196 I_{u0} - .02803 I_{w0} + .01476 I_{\theta0} - .1543 I'_{\theta0}, \\ B &= -(1 - .0008856) I_{u0} - .008198 I_{w0} - .01621 I_{\theta0} + 1.372 I'_{\theta0}, \\ D &= .3577 I_{u0} - .2940 I_{w0} - 172.0 I_{\theta0} - 29.89 I'_{\theta0}. \end{aligned} \quad (23)$$

The solutions (22) of the equations of motion of the aeroplane involve imaginary numbers from which they may be freed by using A , B , C , D in place of C_{11} , C_{12} , C_{13} , C_{14} . The equations then become

$$\begin{aligned} u &= e^{-.18t} [A \cos 2.43t + C \sin 2.43t] \\ &\quad + e^{-.0654t} [B \cos .187t + D \sin .187t] + I_u, \\ w &= e^{-.18t} [(34.5 C - 4.04 A) \cos 2.43t \\ &\quad - (34.5 A + 4.04 C) \sin 2.43t] \\ &\quad + e^{-.0654t} [(0.002587 D - .1058 B) \cos .187t \\ &\quad - (.002587 B + .1058 D) \sin .187t] + I_w, \end{aligned}$$

$$\begin{aligned} \theta = e^{-.18t} [& -(.1132 A + .0946 C) \cos 2.43t \\ & + (.0946 A - .1132 C) \sin 2.43t] \\ & + e^{-.0654t} [(.00278 B + .005799 D) \cos .187t \\ & + (.002478 D - .005799 B) \sin .187t] + I_{\theta}. \end{aligned}$$

These formulas enable us to study any particular gust we desire.

It is merely necessary to find the particular solutions, then the constants A, B, C, D . We shall reduce the coefficients in the parentheses. Then

$$u = e^{-.18t} (A \cos 2.43t + C \sin 2.43t) + e^{-.0654t} (B \cos .187t + D \sin .187t) + I_u, \quad (24a)$$

$$w = e^{-.18t} (A' \cos 2.43t + C' \sin 2.43t) + e^{-.0654t} (B' \cos .187t + D' \sin .187t) + I_w, \quad (24b)$$

$$\theta = e^{-.18t} (A'' \cos 2.43t + C'' \sin 2.43t) + e^{-.0654t} (B'' \cos .187t + D'' \sin .187t) + I_{\theta}, \quad (24c)$$

where

$$\begin{aligned} A' &= -.1066 I_{u0} - 1.0001 I_{w0} + .4436 I_{\theta0} + .220 I'_{\theta0}, \\ C' &= .04346 I_{u0} - .1696 I_{w0} - .6190 I_{\theta0} + 47.93 I'_{\theta0}, \\ B' &= .1066 I_{u0} + .000107 I_{w0} - .4436 I_{\theta0} - .220 I'_{\theta0}, \\ D' &= -.03523 I_{u0} + .03112 I_{w0} + 18.20 I_{\theta0} + 3.158 I'_{\theta0}, \end{aligned} \quad (25)$$

$$\begin{aligned} A'' &= +.0004024 I_{u0} + .001724 I_{w0} - .003231 I_{\theta0} + .1698 I'_{\theta0}, \\ C'' &= +.0002778 I_{u0} - .003947 I_{w0} - .000136 I_{\theta0} - .1123 I'_{\theta0}, \\ B'' &= -.0004024 I_{u0} - .001724 I_{w0} - .99676 I_{\theta0} - .1698 I'_{\theta0}, \\ D'' &= .006683 I_{u0} - .000681 I_{w0} - .4261 I_{\theta0} - .08201 I'_{\theta0}. \end{aligned} \quad (26)$$

In any particular case the calculation of the coefficients in (24) from (23), (25), (26) is likely to be relatively simple because there are so many terms that for that case may be negligible.

ARTICLE 5.

SOME SPECIAL GUSTS.

If we wish to represent a gust which, starting from the condition of still air, increases to a certain intensity J we may use the function

$$J (1 - e^{-rt}). \quad (24)$$

The value of r determines the sharpness of the gust. If $r=1$, the gust has reached about two-thirds of its value in one second; if $r=5$, the gust has reached two-thirds of its value in one-fifth of a second; if $r=\frac{1}{5}$, the two-thirds intensity is reached in 5 seconds. We may perhaps regard $r=1$ as giving a moderately sharp gust, $r=5$ as giving a very sharp, and $r=\frac{1}{5}$ as giving a tolerably mild gust. The function (24) has the advantage of being in such form that the determination of the particular integrals is easy. (See Wilson's Advanced Calculus.)

CASE 1. *Head-on gust—mild.* $u_1 = J(1 - e^{-2t})$.

In equations (20) we let $u_1 = J(1 - e^{-2t})$, $w_1 = q_1 = 0$. Then

$$\begin{aligned} I_u &= -J(1 - .247 e^{-2t}), & I_{u_0} &= -.753J, \\ I_w &= .082J e^{-2t}, & I_{w_0} &= -.082J, \\ I_\theta &= -.00495J e^{-2t}, & I'_{\theta_0} &= -.0049J, \\ I'_\theta &= .00099J e^{-2t}, & I'_{\theta_0} &= .00099J. \end{aligned}$$

(N. B.—The total increase J of the wind occurs everywhere as a factor and may be omitted—the results then are for an increase of 1 foot-second.)

$$u = J e^{-.0654t} (.622 \cos .187t + .630 \sin .187t) - J(1 - .247 e^{-2t}),$$

$$w = J e^{-.187t} (-.004 \cos 2.43t + .003 \sin 2.43t) - J e^{-.0654t} (.078 \cos .187t + .059 \sin .187t) + .082J e^{-2t},$$

$$\theta = J e^{-.0654t} (.00495 \cos .187t - .0031 \sin .187t) - .00495J e^{-2t}.$$

It appears from these equations that the effect of a mild head-on gust of magnitude J is as follows: (1) The machine takes up an easy slowly damped oscillation in u of amplitude about 89 per cent of J ; after the oscillation dies out the machine is making a speed J less relative to the ground and hence the original speed relative to the wind. (2) There is a rapidly damped oscillation in w of rather small magnitude and a slowly damped one of about 10 per cent of J , the final condition being that of horizontal flight. (3) There is a slow oscillation in pitch of about .0058 J radians or about .32 J° . If the magnitude J is great, the pitching becomes so marked that the approximate method of solution can no longer be considered valid—a gust of 20 foot-seconds causing a pitch of some 6° . As the period is long (about one-half minute) the pilot should have ample time to correct the trouble before it produces serious consequences.

The result of a tail-on gust is the opposite of that of the head-on gust and therefore need not be treated separately. For the head-on gust J is negative; for a rear gust, positive.

To calculate the stresses on the machine or operator caused by the gust we have merely to find the accelerations du/dt and dw/dt of which the first is (approximately)—

$$du/dt = J e^{-.0654t} (.08 \cos .187t - .16 \sin .187t) - .05J e^{-2t}.$$

This acceleration reaches a maximum of something of the order of $J/10$; and if J should be 20 foot-seconds, the acceleration would be only about 2, or 6 per cent of g —not a large amount. The acceleration dw/dt is likewise small. (N. B.—The initial accelerations du/dt and dw/dt should vanish, because the gust starts from zero. That the initial values are not exactly zero in the above formulas is due to the roughness of the final calculations for u and w .)

The path of the machine varies from the horizontal by the amount

$$z = \int_0^t (w + 115.5\theta) dt$$

which accounts for the effect of the vertical velocity and of the climbing in the path. The result is (roughly)

$$z = J \int_0^t e^{-.0654t} (.5 \cos .187t - .4 \sin .187t) dt - .5e^{-.2t},$$

$$z = J[e^{-.0654t}(\cos .187t + 3 \sin .187t) + 2.5e^{-.2t} - 3.5].$$

The motion is oscillatory approaching as a limit $z = -3.5 J$. The machine will rise 70 feet when the gust is 20 foot-seconds head-on.

CASE 2. *Up gust—mild.* $w_1 = J(1 - e^{-.2t})$.

$$\begin{aligned} I_u &= .305 J e^{-.2t}, & I_{u_0} &= .305 J, \\ I_w &= J(1 - 1.012e^{-.2t}), & I_{w_0} &= -.012 J, \\ I_\theta &= .000737 J e^{-.2t}, & I_{\theta_0} &= .000737 J, \\ I_{\dot{\theta}} &= -.000147 J e^{-.2t}, & I_{\dot{\theta}_0} &= -.000147 J. \end{aligned}$$

$$u = J e^{-.0654t} (-.305 \cos .187t - .0108 \sin .187t) + .305 J e^{-.2t},$$

$$w = J e^{-.418t} (-.02 \cos 2.43t + .026 \sin 2.43t) + J e^{-.0654t} (.032 \cos .187t + .002 \sin .187t) + J(1 - 1.012e^{-.2t}),$$

$$\theta = J e^{-.0654t} (.0008 \cos 187t + .0017 \sin .187t) + .00074e^{-.2t}.$$

The effect of the up gust is to set up a small long oscillation in u of magnitude about $0.3 J$, a very small oscillation in w , and a long oscillation of intensity $.0018 J$ radians or $.11 J^\circ$ in θ . The comparative effects on the velocity and angle in the case of head-on and up gusts show that the up gust is only about one-third as effective as the head-on gust. The accelerations in the case of the up gust are all small.

To find the displacement in a vertical direction we integrate as before.

$$z = \int_0^t (w + 115.5\theta) dt.$$

It is scarcely necessary to trouble with the trigonometric terms partly because the motion is less pronounced than in Case 1, partly because there is here the secular term Jt , which will carry the machine up with the gust and will be the chief effect after the lapse of a short time.

A down gust is in every way the opposite of an up gust and need not be separately treated.

CASE 3. *Rotary gust—mild.* $q_1 = J(1 - e^{-.2t})$.

$$\begin{aligned} I_u &= -J(810.6 - 475.5e^{-.2t}), & I_{u_0} &= -135.1 J. \\ I_w &= J(86.21 - 74.87e^{-.2t}), & I_{w_0} &= 11.34 J. \\ I_\theta &= J(2.865 + .691e^{-.2t}), & I_{\theta_0} &= 3.556 J. \end{aligned}$$

$$I_{\theta} = -.138 J e^{-x}, \quad P_{\theta_0} = -.138 J.$$

$$I_u = J e^{-4.18t} (.46 \cos 2.43t + .1875 \sin 2.43t) \\ + J e^{-.0354t} (134.7 \cos .187t - 659 \sin .187t) \\ - J (610.6 - 475.5 e^{-x}),$$

$$I_w = J e^{-4.18t} (4.61 \cos 2.43t - 16.82 \sin 2.43t) \\ + J e^{-.0354t} (-15.95 \cos .187t + 70.08 \sin .187t) \\ + J (86.21 - 74.87 e^{-x}),$$

$$I_{\theta} = J e^{-4.18t} (-.0698 \cos 2.43t + .0223 \sin 2.43t) \\ + J e^{-.0354t} (-3.487 \cos .187t - 2.414 \sin .187t) \\ + J (2.865 + .691 e^{-x}).$$

The effect of the rotary gust is a long oscillation in u (the short one is negligible) of magnitude about $670 J$, a short oscillation in w of about $17 J$ and a long one of about $71 J$, a long oscillation in θ of about $4.1 J$. The comparison with former cases may be made by supposing first that the oscillation in u may reach some 20 foot-seconds. Then $J = 1/33 = .03$. The amplitude of the oscillation in θ is then some 0.12 radians, which is an amount comparable with the 6° of Case 1. To get an idea of what $J = .03$ means, we may note that if a gust of 20 foot-seconds is due to a whirl of the air as a solid body with $q_1 = .03$, the radius of the whirl is 660 feet. We may therefore say that the effect of a whirl of radius 660 generating velocity of 20 foot-seconds is of itself about equal to that of a head-on velocity of that amount. If, however, a machine ran into such a whirl, it would experience both the effect of the whirl and of the linear velocity generated by it and would be disturbed considerably more than if it had encountered a pure head-on gust. We may therefore say that if the head-on gust arises from a whirl of materially less than 660-foot radius, the effect of the whirl is quite considerably larger than that due to a straight head-on gust of equal magnitude.

The conditions after enough time has elapsed to allow the exponential term to become small is

$$I_u = -610.6 J. \quad I_w = 86.2 J. \quad I_{\theta} = 2.865 J.$$

It is therefore seen that the machine takes up the head-on velocity, acquires a small upward velocity, and is inclined at an angle $2.865 J$ radians to the horizontal, these effects being due exclusively to the rotary motion of the air. The path in space could be obtained by integration, but (like the effects previously mentioned) would not be the true path if the rotary motion were accompanied by horizontal or vertical linear gusts. It seems therefore scarcely worth while to find the path.

The value that I attach to this theory of rotary gusts does not arise so much from the fact that such gusts seem nowhere to have been treated as from the revelation of the powerful effects of such gusts. When a machine is flying low it must expect to meet air which has been set in rotation by the friction of the wind against the ground, against buildings, or against trees. It seems certain that very material angular velocities might be set up and that these might (owing to their short radius) induce only moderate linear gusts. In such cases, if they can arise as assumed, the machine

might behave very much worse than could be foreseen when nothing is known of rotary gusts. It is not unlikely, however, that rotary gusts would be very irregular themselves and that, before the machine could feel the full effects of one, the gust might have disappeared. In the same way rotation could be generated at the interface between dark and light regions of air—indeed any sharp relative motion of the air is likely to contain rotation.

CASE 4. *Head-on gust—moderate.* $u_1 = J(1 - e^{-t})$.

$$I_u = -J(1 + .09876e^{-t}), \quad I_{u_0} = -1.09876 J,$$

$$I_w = .1307 J e^{-t}, \quad I_{w_0} = .1307 J,$$

$$I_\theta = -.00196 J e^{-t}, \quad I_{\theta_0} = -.00196 J,$$

$$I'_{\theta_0} = +.00196 J e^{-t}, \quad I'_{\theta_0} = +.00196 J.$$

$$u = J e^{-4.18t} (-.000876 \cos 2.43t - .000486 \sin 2.43t) \\ + J e^{-.0654t} (1.09944 \cos .187t - .1528 \sin .187t) \\ - J (1 + .09876e^{-t}),$$

$$w = J e^{-4.18t} (-.01405 \cos 2.43t + .02528 \sin 2.43t) \\ + J e^{-.0654t} (-.1159 \cos .187t + .01493 \sin .187t) \\ + .1307 J e^{-t},$$

$$\theta = J e^{-4.18t} (.0001207 \cos 2.43t - .00000895 \sin 2.43t) \\ + J e^{-.0654t} (.001838 \cos .187t - .006755 \sin .187t) \\ - .00196 J e^{-t}.$$

The short oscillation in u is negligible not only in regard to its magnitude but even as far as accelerations are concerned. Then

$$du/dt = J e^{-.0654t} (-.1 \cos .187t + .21 \sin .187t) + .1 J e^{-t}.$$

This is at most about .25 J , or 5 foot-seconds² if $J = 20$. The short oscillation in w is considerably smaller than the long, but when the coefficients -4.18 and 2.43 are brought in by differentiating to find dw/dt , whereas $-.0654$ and $.187$ are brought in by the long oscillation, it appears that the short oscillation is effective in determining the acceleration. Thus

$$dw/dt = J e^{-4.18t} (.12 \cos 2.43t - .07 \sin 2.43t) \\ + J e^{-.0654t} (.01 \cos .187t) - .13 J e^{-t}.$$

The amount of this acceleration is at most about $J/12$, one-third that in u ; the effect, however, is produced very quickly, in the first half second.

In integrating to find the path in a vertical plane we may neglect the short oscillation, because in this case we divide by -4.18 and 2.43 , whereas for the long oscillation we divide by $-.0654$ and $.187$. Then

$$z = \int_0^t (w + 115.5\theta) dt \\ = J \int_0^t [e^{-.0654t} (.106 \cos .187t - .765 \sin .187t) - .095e^{-t}] dt \\ = J e^{-.0654t} (2.3 \sin .187t + 3.5 \cos .187t) + .095 J e^{-t} - 3.6 J.$$

The final condition is a rise of $-3.6 J$, an amount which agrees with that in the case of the mild gust (Case 1) in as far as the rough calculation of that case permits us to judge.

CASE 5. *Up gust—moderate.* $w_1 = J(1 - e^{-t})$.

$$I_u = .0773 J e^{-t}, \quad I_{u_0} = .0773 J,$$

$$I_w = -J(1 - 1.205 e^{-t}), \quad I_{w_0} = .205 J,$$

$$I_\theta = -.003069 J e^{-t}, \quad I_{\theta_0} = -.003069 J,$$

$$I'_\theta = .003069 J e^{-t}, \quad I'_{\theta_0} = .003069 J.$$

$$u = J e^{-4.18t} (-.002641 \cos 2.43t - .00651 \sin 2.43t) \\ + J e^{-.0654t} (.07466 \cos .187t + .4034 \sin .187t) + .0773 J e^{-t},$$

$$w = J e^{-4.18t} (-.2139 \cos 2.43t + .1174 \sin 2.43t) \\ + J e^{-.0654t} (.008943 \cos .187t - .02337 \sin .187t) - J(1 - 1.205 e^{-t}),$$

$$\theta = J e^{-4.18t} (.0009148 \cos 2.43t + .000487 \sin 2.43t) \\ + J e^{-.0654t} (.002154 \cos .187t - .001432 \sin .187t) - .003069 J e^{-t}.$$

The short oscillation is negligible in u as far as concerns u itself. In calculating the acceleration du/dt the short oscillation is not negligible relative to the long; but the acceleration is small any way. The effect of an up gust J on u is about one-third the effect of an equal head-on gust (see Case 2).

The short oscillation is the main thing in w —its amplitude is about $J/4$, whereas the amplitude of the long oscillation is about $J/40$, or one-tenth as much. The acceleration dw/dt may therefore be calculated exclusively from the short oscillation; it is

$$dw/dt = J e^{-4.18t} (1.2 \cos 2.43t) - J(1 - e^{-t}).$$

This means values approximately as follows:

$$t = 0, \quad \frac{1}{8}, \quad \frac{1}{4}, \quad \frac{1}{2}, \quad \frac{3}{4}, \\ acc. = 0, \quad -.35 J, \quad -.6 J, \quad -.7 J, \quad -.6 J.$$

If J should be 20 foot-seconds, the maximum acceleration would be about $g/2$, even a gust of 10 foot-seconds would produce an acceleration of $g/4$. Such accelerations coming upon the pilot in one-half a second might considerably surprise and disturb him. An addition of 25 to 50 per cent in the apparent weight of the machine could hardly strain it to an appreciable extent in view of the large factor of safety used in the design. (N. B.—For an up gust J is negative. For a down gust the operator would lose 25 to 50 per cent of his weight.)

The path of the machine in space is not of great importance in this case. The chief feature is the general drift of the machine with the current.

CASE 6. *Rotary gust—moderate.* $q_1 = J(1 - e^{-t})$.

As we know so little of the rotation in the atmosphere and as nothing particular of interest seems to be indicated for this case over and above what was found in Case 3, we shall not carry out the calculations.

CASE 7. *Head-on gust—sharp.* $u_1 = J(1 - e^{-5t})$.

$$\begin{aligned} I_u &= -J(1 + .01872 e^{-5t}), & I_{u0} &= -1.01872 J, \\ I_w &= -.05102 J e^{-5t}, & I_{w0} &= -.05102 J, \\ I_\theta &= -.0008896 J e^{-5t}, & I_{\theta0} &= -.0008896 J, \\ I'_\theta &= .004448 J e^{-5t}, & I'_{\theta0} &= .004448 J. \end{aligned}$$

$$\begin{aligned} u &= J e^{-1.18t} (-.005632 \cos 2.43t + .003986 \sin 2.43t) \\ &\quad + J e^{-.0654t} (1.02435 \cos .187t - .3294 \sin .187t) \\ &\quad - J(1 + .01872 e^{-5t}), \\ w &= J e^{-1.18t} (.1603 \cos 2.43t + .1782 \sin 2.43t), \\ &\quad + J e^{-.0654t} (-.1093 \cos .187t + .0322 \sin .187t) \\ &\quad - .05102 J e^{-5t}, \\ \theta &= J e^{-1.18t} (.00026 \cos 2.43t - .000984 \sin 2.43t), \\ &\quad + J e^{-.0654t} (.000628 \cos .187t - .006755 \sin .187t) \\ &\quad - .0008896 J e^{-5t}. \end{aligned}$$

Here again the short oscillation in u is insignificant. The long oscillation as in Case 4 has an amplitude a little in excess of J . The acceleration du/dt is small of the order $J/5$. The reason that a sharp head gust does not give a large value to du/dt is probably because the gust can blow through the machine; the acceleration is therefore not large except at the loops of the slow oscillation.

The short-period oscillation in w has now become stronger than the long oscillation and the acceleration dw/dt is mostly due to it and may be written

$$dw/dt = J e^{-1.18t} (-.25 \cos 2.43t - 1.13 \sin 2.43t) + .25 J e^{-5t}.$$

The value of the acceleration never gets large because it is damped out before the sine term gets effective—perhaps $-0.4 J$ would be about its maximum value. A sharp head-on gust is therefore about half as effective as a moderate up gust of the same intensity. Since up gusts are perhaps not likely to be as intense as head-on gusts, we might hazard a guess that sharp head-on gusts would inconvenience the pilot about as much as moderate up gusts.

The most important terms in the path in space are

$$z = J e^{-.0654t} (1.2 \sin .187t + 3.5 \cos .187t) - 3.5 J.$$

The total rise is again $-3.5 J$.

CASE 8. *Up gust—sharp.* $w_1 = J(1 - e^{-5t})$.

$$\begin{aligned} I_u &= .06621 J e^{-5t}, & I_{u0} &= .06621 J, \\ I_w &= -J(1 - .5605 e^{-5t}), & I_{w0} &= -.4395 J, \\ I_\theta &= -.00778 J e^{-5t}, & I_{\theta0} &= -.00778 J, \\ I'_{\theta0} &= .0389 J e^{-5t}, & I'_{\theta0} &= .0389 J. \end{aligned}$$

$$\begin{aligned} u &= J e^{-1.18t} (-.05714 \cos 2.43t + .006 \sin 2.43t) \\ &\quad + J e^{-.0654t} (-.00907 \cos .187t + .3285 \sin .187t) \\ &\quad + .06621 J e^{-5t}, \\ w &= J e^{-1.18t} (.4378 \cos 2.43t + 1.947 \sin 2.43t) \\ &\quad + J e^{-.0654t} (.00181 \cos .187t - .03474 \sin .187t) \\ &\quad - J(1 - .5605 e^{-5t}), \end{aligned}$$

$$\theta = J e^{-.418t} (.0059 \cos 2.43t - .0122 \sin 2.43t) \\ + J e^{-.0654t} (.001883 \cos .187t + .0008667 \sin .187t) \\ - .00778 J e^{-5t}.$$

The oscillation in u is of long period, and the acceleration in u is small. The oscillation in w has a short-period term of great importance at the start, but except for this there is very little oscillation in w . The acceleration is

$$dw/dt = J e^{-.418t} (2.9 \cos 2.43t - 9.2 \sin 2.43t) - 2.8 J e^{-5t}.$$

(N. B.—The value of dw/dt when $t=0$ should be 0 instead of $J/10$. The failure to check seems due to multiplication of errors, which is unavoidable. The accuracy of the work in Case 8 and Case 5 appears reduced to two figures.) The acceleration is now very serious indeed; it is about $-9.2 J e^{-.418t} \sin 2.43t$, as the other two terms come near canceling. The maximum value occurs when $t=.217$, a little over one-fifth of a second, as is then about $-1.85 J$. If J should be as large as -18 foot-seconds, the acceleration would equal $g=32$. Clearly such a sharp gust if it existed would be very dangerous from the sudden forces it would bring into play. As the machine, however, would travel only about 24 feet during one-fifth second, it is reasonable to doubt whether in so short a distance so large a change in vertical air velocity could occur.

The path in space is found to be approximately

$$z = -1.2 J e^{-.418t} \cos 2.43t + 1.1 J e^{-.0654t} \cos .187t - .1 J e^{-5t} + .2 J - Jt.$$

The final effect is the general drift with the gust, less a lag of $J/5$.

ARTICLE 6.

THE CONSTRAINED AEROPLANE.

If an aeroplane is constrained to remain always horizontal by mechanism which does not otherwise alter the machine or its dynamical properties, the equations of motion in a gust may be found from our previous equations by setting $\theta=q=0$. Then

$$\begin{aligned} (D - X_u) u - X_w w &= X_u u_1 + X_w w_1 + X_q q_1, \\ -Z_u u + (D - Z_w) w &= Z_u u_1 + Z_w w_1 + Z_q q_1, \\ -M_u u - M_w w &= M_u u_1 + M_w w_1 + M_q q_1 + F, \end{aligned}$$

where F is the effective force due to the constraint and is assumed to affect moments only, not components of horizontal or vertical force. The last equation merely determines F .

With the numerical data we find for high speed

$$\begin{aligned} (D + 128)u - .162w &= -.128u_1 + .162w_1, \\ .557u + (D + 3.95)w &= -.557u_1 - 3.95w_1, \\ F &= -.174(w + w_1) + 150q_1. \end{aligned}$$

The natural motion of the machine when slightly disturbed in steady air is found from

$$\Delta' = \begin{vmatrix} D + .128 & -.162 \\ .557 & D + 3.95 \end{vmatrix} = D^2 + 4.078D + .598 = 0.$$

The roots are

$$D = -2.039 \pm 1.887 = -3.926 \text{ or } -0.152.$$

We thus find the first result: The machine, when disturbed, does not execute a double damped oscillation, but has an aperiodic motion of the form

$$C_1 e^{-3.93t} + C_2 e^{-0.15t}.$$

The two damping factors -3.93 and -0.15 lie between the values -4.18 and $-.0654$ previously found.

The unconstrained machine was stable for the speeds 79, 51, and 47 mile-hours; unstable for 45.2 mile-hours and lower speeds. If we take the data for 47 mile-hours and use them for the constrained motion, we find

$$\Delta'' = \begin{vmatrix} D + .151 & .075 \\ .936 & D + 1.46 \end{vmatrix} = D^2 + 1.61D + .150 = 0,$$

of which the roots are -1.51 and $+1.0$. The natural motion of the machine is therefore of the form

$$C_1 e^{-1.51t} + C_2 e^{+1.0t}.$$

The second factor indicates instability; the motion due to it increases instead of subsides and reaches 2.78 times its original value in 10 seconds. We thus find the second result: The machine, when constrained, becomes unstable at a higher speed than when free—it is to this extent a more dangerous machine.

We shall now return to the case of high speed and compute the effect of certain gusts on the constrained machine for comparison with the effect of the same gusts on the free machine. The general solutions are

$$\begin{aligned} u &= -.0426 C_1 e^{-3.93t} + C_2 e^{-0.15t} + I_u, \\ w &= C_1 e^{-3.93t} - .147 C_2 e^{-0.15t} + I_w, \\ C_1 &= -.148 I_{u0} - 1.006 I_{w0}, \\ C_2 &= -1.006 I_{u0} - .0429 I_{w0}, \\ \Delta' u &= -(1.28 D + .598) u_1 + .162 D w_1, \\ \Delta' w &= -(3.95 D + .598) w_1 - .557 D u_1. \end{aligned}$$

CASE 1. *Head-on gust—mild.* $u_1 = J (1 - e^{-2t})$.

$$\begin{aligned} I_u &= -J (1 + 3.20 e^{-2t}), & I_{u0} &= -4.20 J, \\ I_w &= .622 J e^{-2t}, & I_{w0} &= .622 J, \\ u &= 4.19 J e^{-1.5t} - J (1 + 3.19 e^{-2t}), \\ w &= -.62 J e^{-1.5t} + .62 J e^{-2t}. \end{aligned}$$

The machine takes up the gust as before, of course. There is no oscillation. There is practically no acceleration in either u or w . The path in space is

$$z = J(4.1 e^{-.15t} - 3.1 e^{-.2t}) - J.$$

The total rise is only $-J$. In every way the motion in this case is easier in the constrained than in the free aeroplane.

CASE 2. *Up gust—mild.* $w_1 = J(1 - e^{-.2t})$.

$$\begin{aligned} I_u &= -.186 J e^{-.2t}, & I_{w0} &= -.186 J, \\ I_w &= -J(1 - 1.079 e^{-.2t}), & I_{w0} &= .079 J. \\ u &= .186 J e^{-.15t} - .186 J e^{-.2t}, \\ w &= -.052 J e^{-3.93t} - .027 J e^{-.15t} - J(1 - 1.079 e^{-.2t}). \end{aligned}$$

The motion is again exceedingly moderate in all respects.

CASE 3. *Rotary gusts.* These can have no effect except upon the constraining moment F .

CASE 4. *Head-on gust—moderate.* $u_1 = J(1 - e^{-t})$.

$$\begin{aligned} I_u &= -J(1 + .1895 e^{-t}), & I_{w0} &= -.1895 J, \\ I_w &= .2246 J e^{-t}, & I_{w0} &= .2246 J. \\ u &= .002 J e^{-3.93t} + 1.187 J e^{-.15t} - J(1 + .189 e^{-t}), \\ w &= -.05 J e^{-3.93t} - .174 J e^{-.15t} + .224 J e^{-t}, \\ \frac{du}{dt} &= -.008 J e^{-3.93t} - .180 J e^{-.15t} + 1.89 J e^{-t}, \\ \frac{dw}{dt} &= .197 J e^{-3.93t} + .027 J e^{-.15t} - .224 J e^{-t}, \\ z &= 1.16 J e^{-.15t} - .22 J e^{-t} - .94 J. \end{aligned}$$

The motion is again decidedly moderate.

CASE 5. *Up gust—moderate.* $w_1 = J(1 - e^{-t})$.

$$\begin{aligned} I_u &= -.0653 J e^{-t}, & I_{w0} &= -.0653 J, \\ I_w &= -J(1 - 1.350 e^{-t}), & I_{w0} &= .350 J. \\ u &= .0144 J e^{-3.93t} + .0507 J e^{-.15t} - .0653 J e^{-t}, \\ w &= -.343 J e^{-3.93t} - .007 J e^{-.15t} - J(1 - 1.350 e^{-t}), \\ \frac{dw}{dt} &= +1.35 J e^{-3.93t} - 1.35 J e^{-t}. \end{aligned}$$

The motion is easy except for the acceleration in w , which has a maximum when $t = .46$ and is then equal to about $-.62 J$. If the gust should have an intensity of 10 foot-seconds the maximum acceleration would be about $g/5$.

CASE 6. *Head-on gust—sharp.* $u_1 = J(1 - e^{-5t})$.

$$\begin{aligned} I_u &= -J(1 + .00795 e^{-5t}), & I_{w0} &= -1.008 J, \\ I_w &= -.5275 J e^{-5t}, & I_{w0} &= -.5275 J. \\ u &= -.029 J e^{-3.93t} + 1.037 J e^{-.15t} - J(1 + .008 e^{-5t}), \\ w &= .680 J e^{-3.93t} - .152 J e^{-.15t} - .528 J e^{-5t}, \\ \frac{dw}{dt} &= -2.67 J e^{-3.93t} + .02 J e^{-.15t} + 2.64 J e^{-5t}, \\ z &= -.173 J e^{-3.93t} + J e^{-.15t} + .103 J e^{-5t} - .93 J. \end{aligned}$$

The motion, including acceleration, is moderate.

CASE 7. *Up gust—sharp.* $w_1 = J(1 - e^{-5t})$.

$$I_u = .153 J e^{-5t}, \quad I_{w_0} = .153 J,$$

$$I_w = -J(1 + 3.628 e^{-5t}), \quad I_{w_p} = -4.628 J,$$

$$u = -.197 J e^{-3.93t} + .044 J e^{-.15t} + .153 J e^{-5t},$$

$$w = 4.634 J e^{-3.93t} - .006 J e^{-.15t} - J(1 + 3.628 e^{-5t}).$$

$$dw/dt = -18.2 J e^{-3.93t} + 18.2 J e^{-5t},$$

$$z = -1.18 J e^{-3.93t} + .04 J e^{-.15t} + .73 J e^{-5t} + .41 J - Jt.$$

The acceleration dw/dt has a maximum when $t=5/11$ when it is $1.44 J$. This is somewhat serious if J is 10 foot-seconds.

We may now calculate roughly the moment F necessary to produce the constraint.

$$F = -.174(w + w_1) + 150q_1.$$

The last term is effective only when the machine encounters rotating air and will be neglected here.

$$\text{CASE 1. } F = .11 J(e^{-.15t} - e^{-3t}).$$

$$\text{CASE 2. } F = J(.009 e^{-3.93t} + .005 e^{-.15t} - .014 e^{-3t}).$$

$$\text{CASE 4. } F = J(.009 e^{-3.93t} + .030 e^{-.15t} - .039 e^{-t}).$$

$$\text{CASE 5. } F = J(.06 e^{-3.93t} + .0012 e^{-.15t} - .0612 e^{-t}).$$

$$\text{CASE 6. } F = J(-.119 e^{-3.93t} + .0266 e^{-.15t} + .0924 e^{-5t}).$$

$$\text{CASE 7. } F = .811 J(-e^{-3.93t} + e^{-5t}).$$

SUMMARY.

I have indicated the general method, based on the theory of small oscillations, whereby the equations of motion of a stable aeroplane, whether free or constrained to fly without pitch, whether in steady or gusty air, may be completely integrated in such form that, after a certain amount of preliminary calculation, the effects upon the motion of a large number of different gusts may be determined with relative ease. So far as I am aware, no actual method of integration nor any quantitative results of such an integration has previously been published with the exception of the descriptive popular lecture of Glazebrook cited above. I have carried through the actual determination of the effects of gusts in the following cases:

Head-on gusts rising from 0 to J feet per second with various degrees of sharpness.

Up gust of the same type.

Rotary gusts of the same type.

Rear gusts and down gusts are included by merely changing the sign of J . For convenience, it has been assumed that the machine is in still air except for the gustiness; as a matter of fact gusts are usually superposed upon a general steady wind of other than zero

average velocity; but the conditions of flight in still air and in steady air are nearly identical, the only difference being that in the equations of motion the resistance derivatives are calculated from the relative wind, whereas U is the actual velocity over the ground.

It has been found that a stable machine, with controls untouched, running into a head gust of various sharpness and of total intensity J foot-second will swoop up, with some oscillation of no serious character, to a new level about $3.5 J$ feet higher than its previous level. The constrained machine will rise without oscillation to a new level only J feet, or a trifle less, higher than before. The path in a vertical plane is indicated in the diagrams drawn for me by Mr. T. H. Huff. The accelerations arising in the motion are not serious for either the machine or the pilot. It has been found further that a rotary gust may have considerable effect—though in the absence of data as to the intensity and regularity of rotation in the air no definite results can be formulated. Furthermore we find that up gusts operate chiefly in lifting the machine, whether free or constrained, with the gust. The path in space is given in the diagram. There is here in the case of sharp gusts a considerable momentary acceleration in the vertical which may reach a magnitude of about $1.5 J$ foot-seconds.² This would not seriously stress the machine, which is designed to stand accelerations of $6 g$ to $8 g$ in maneuvering, but owing to its sudden and unexpected appearance this acceleration might incommode the pilot—it is indeed the familiar phenomenon of a "bump."

It follows, therefore, that the introduction of the constraint, whether by gyroscopic or other means, serves only to eliminate the natural oscillation in pitch and to diminish, in the case of the head or rear gusts only, the final change of level. As a rear gust of 20 foot-seconds is found to drop the uncontrolled machine by more than 80 feet in 15 seconds, flight at low altitudes is more dangerous in the unconstrained than in the constrained machine. However, the elapsed time is sufficiently great to enable the pilot to check the dip by a suitable movement of his elevator.

To offset any advantages derived from the constraint, we find that this particular machine, when constrained, becomes unstable at a speed between 47 and 51 mile-hours, whereas the free machine remains stable down to a speed between 45 and 47 mile-hours.

MASSACHUSETTS INSTITUTE OF TECHNOLOGY,
Boston, Mass., October 7, 1915.

